

# Cap.3 Combinatii de profile

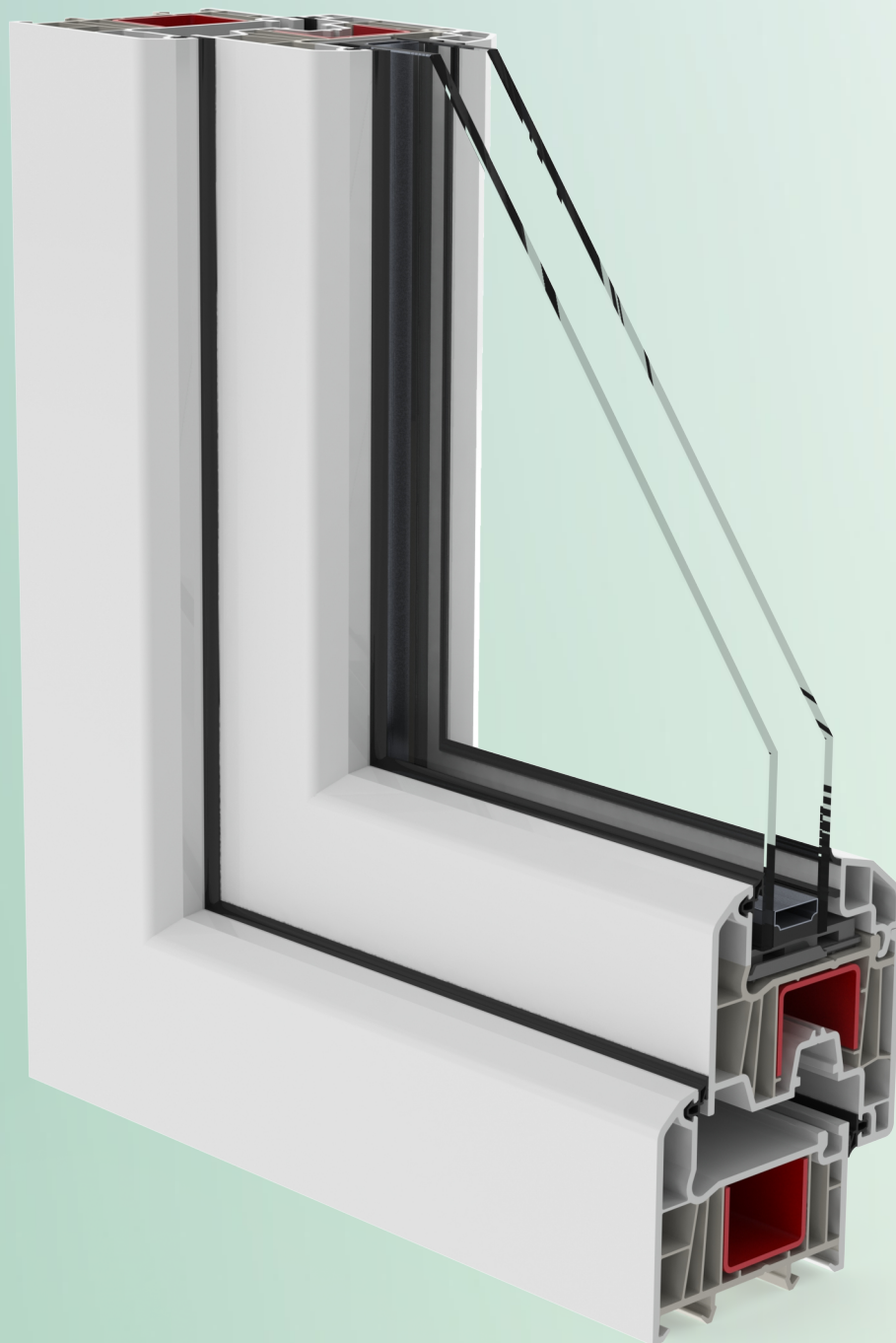

Cap.3 Combinatii de profile

Profil rama - **S.70101**

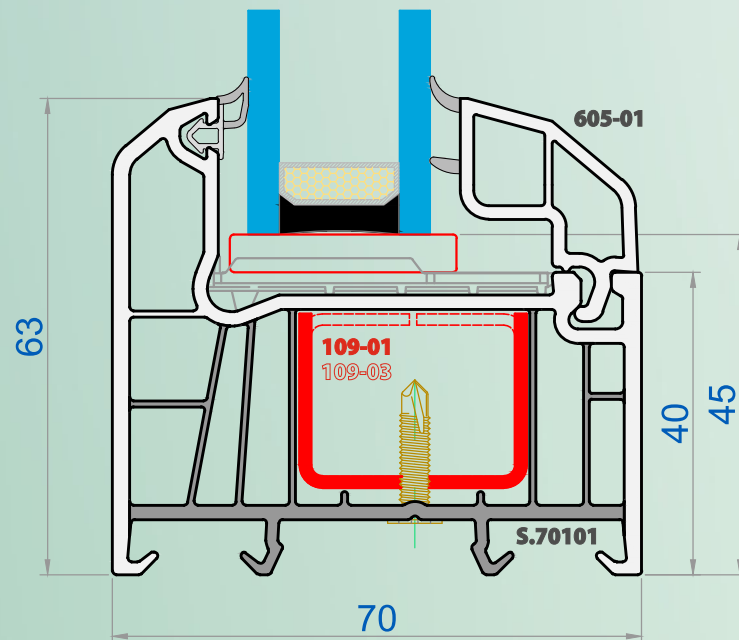
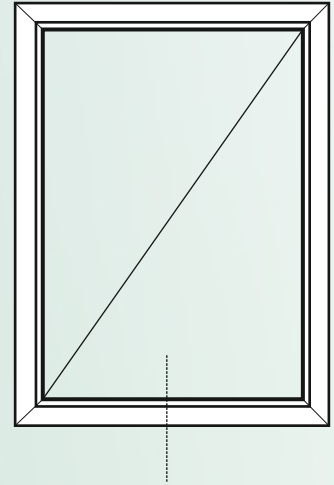

Cap.3 Combinatii de profile

Profil rama - **S.70101**

Profil cercevea - **S.70201**

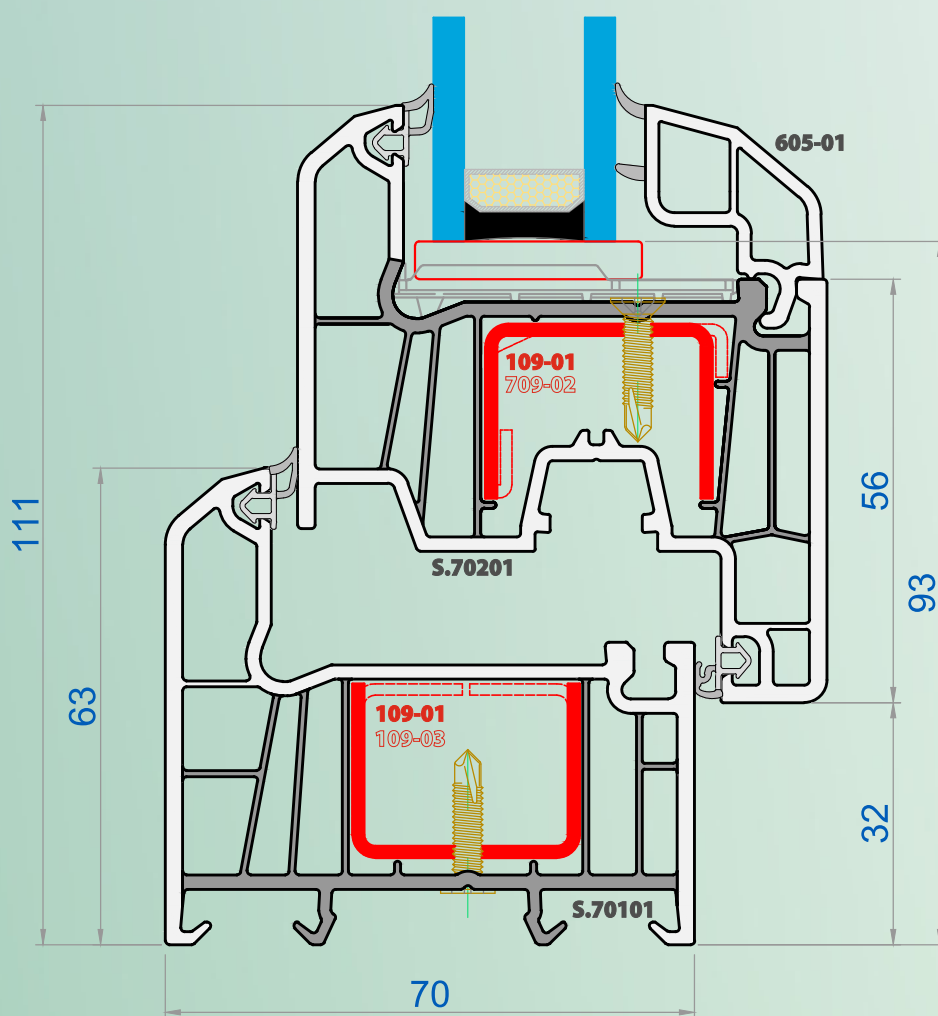
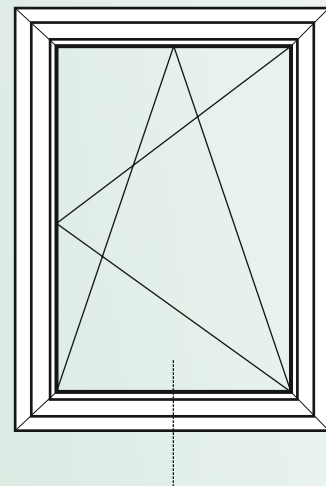

Cap.3 Combinatii de profile

Profil rama - **S.70101**

Profil cercevea - **S.70202**

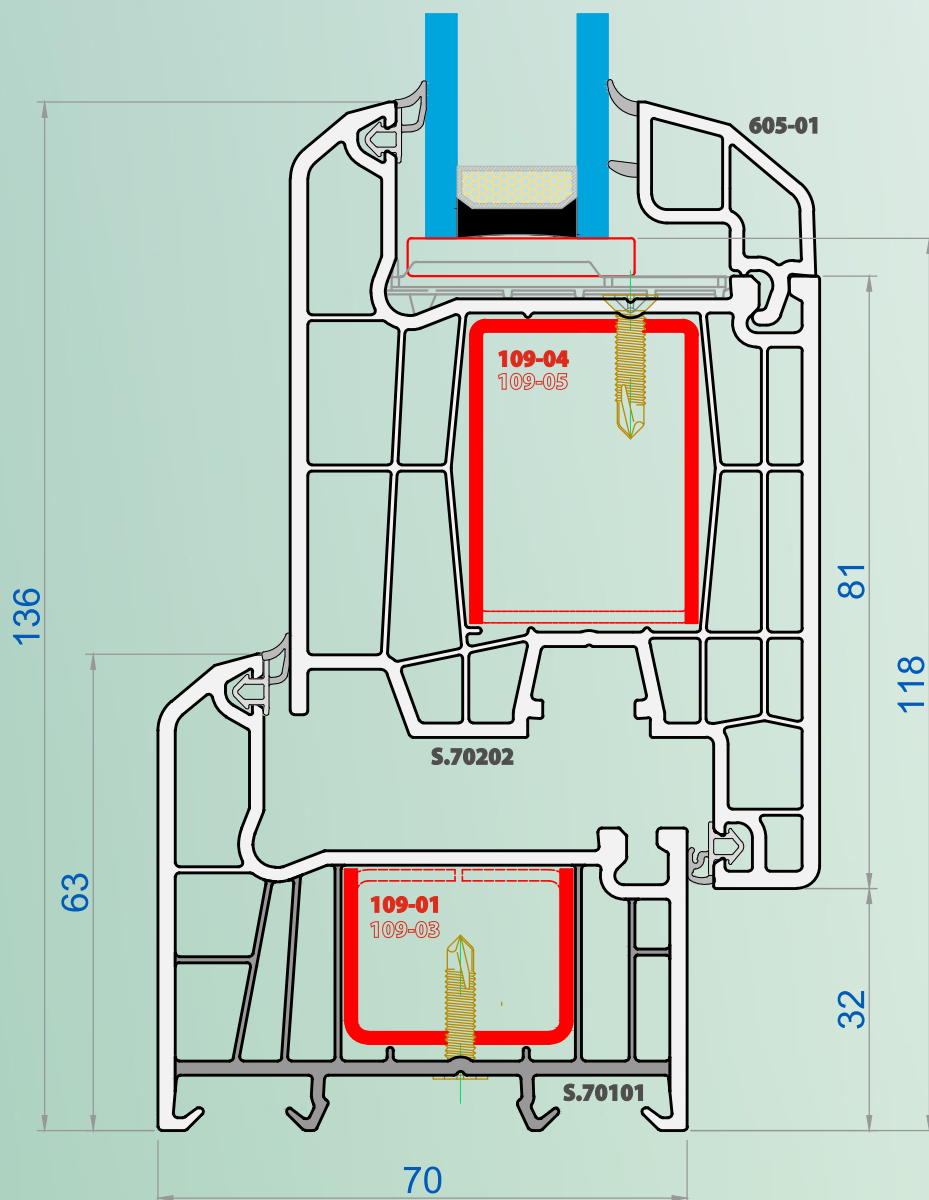
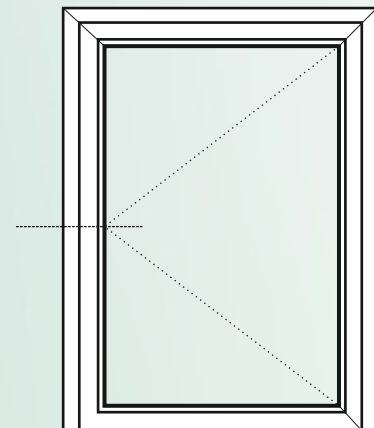

Cap.3 Combinatii de profile

Profil rama - **S.70101**

Profil cercevea - **S.70203**

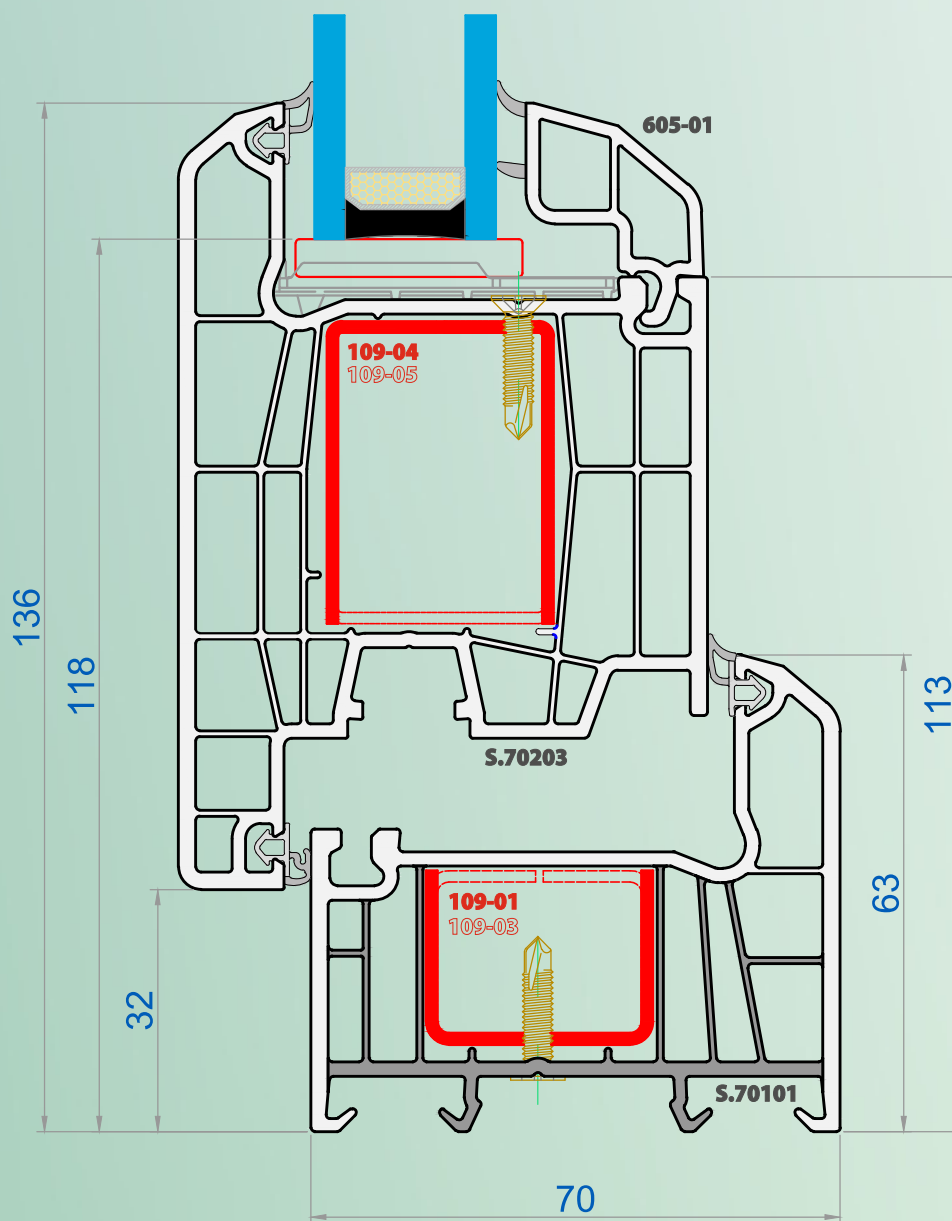
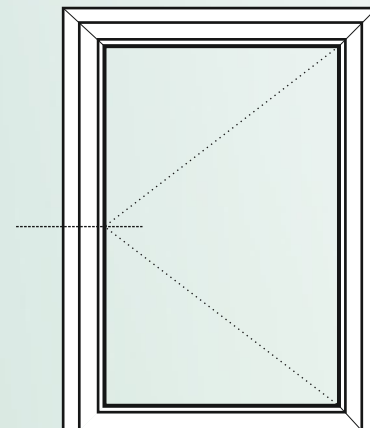

Cap.3 Combinatii de profile

Profil montant - **S.70301**

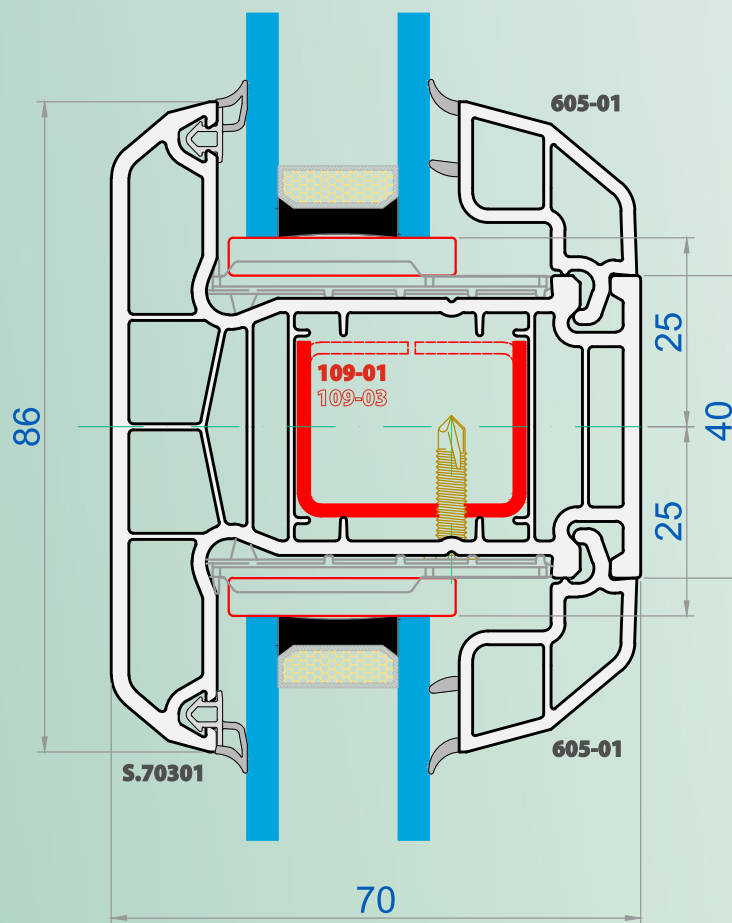
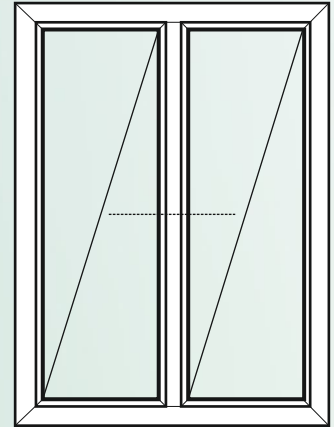

Cap.3 Combinatii de profile

Profil montant - **S.70301**

Profil cercevea - **S.70201**

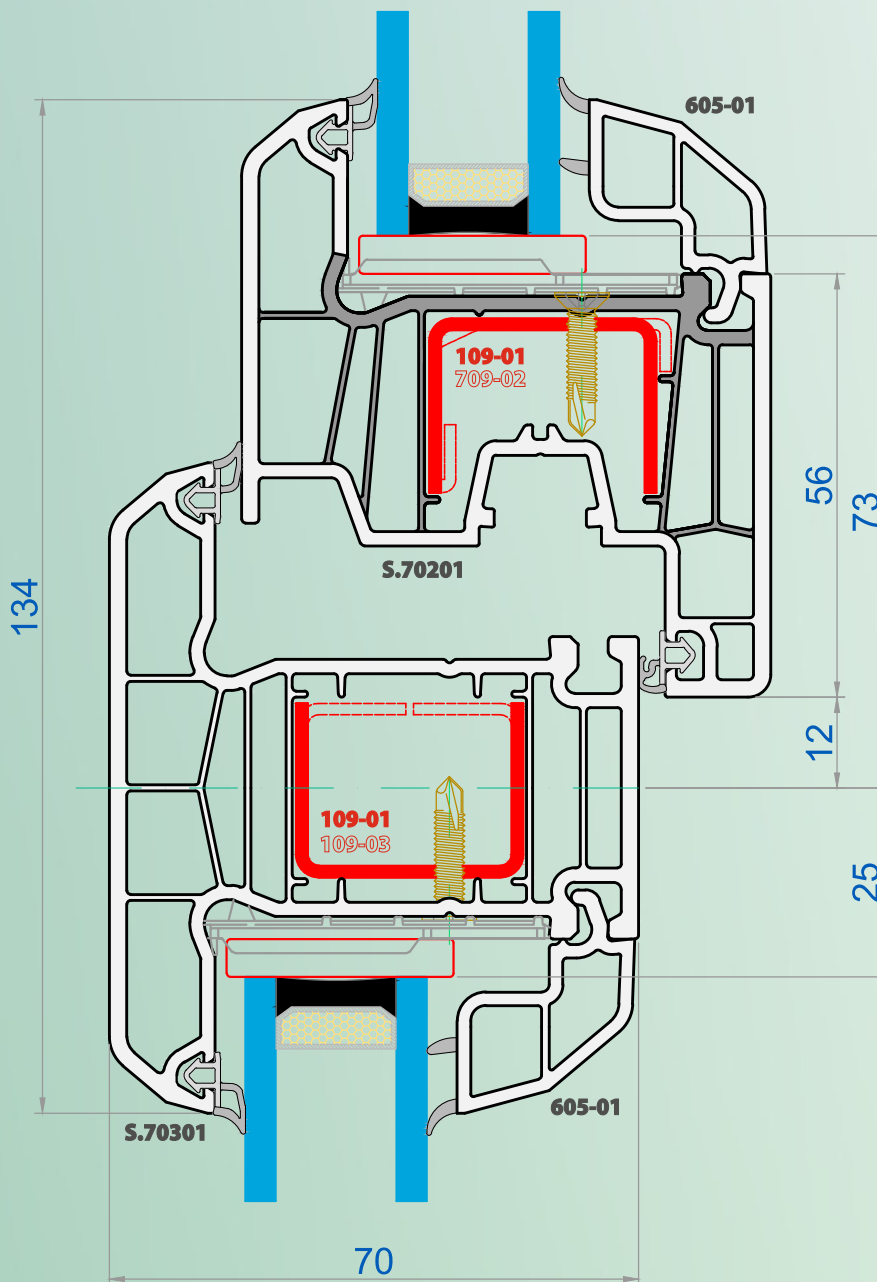
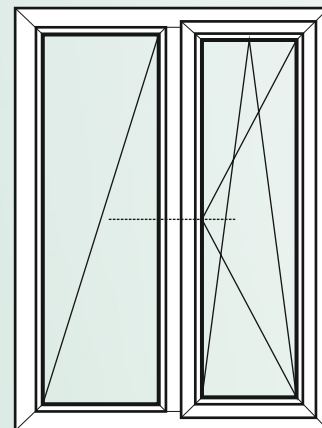

Cap.3 Combinatii de profile

- Profil montant - **S.70301**
- Profil cercevea - **S.70201**
- Profil cercevea - **S.70201**

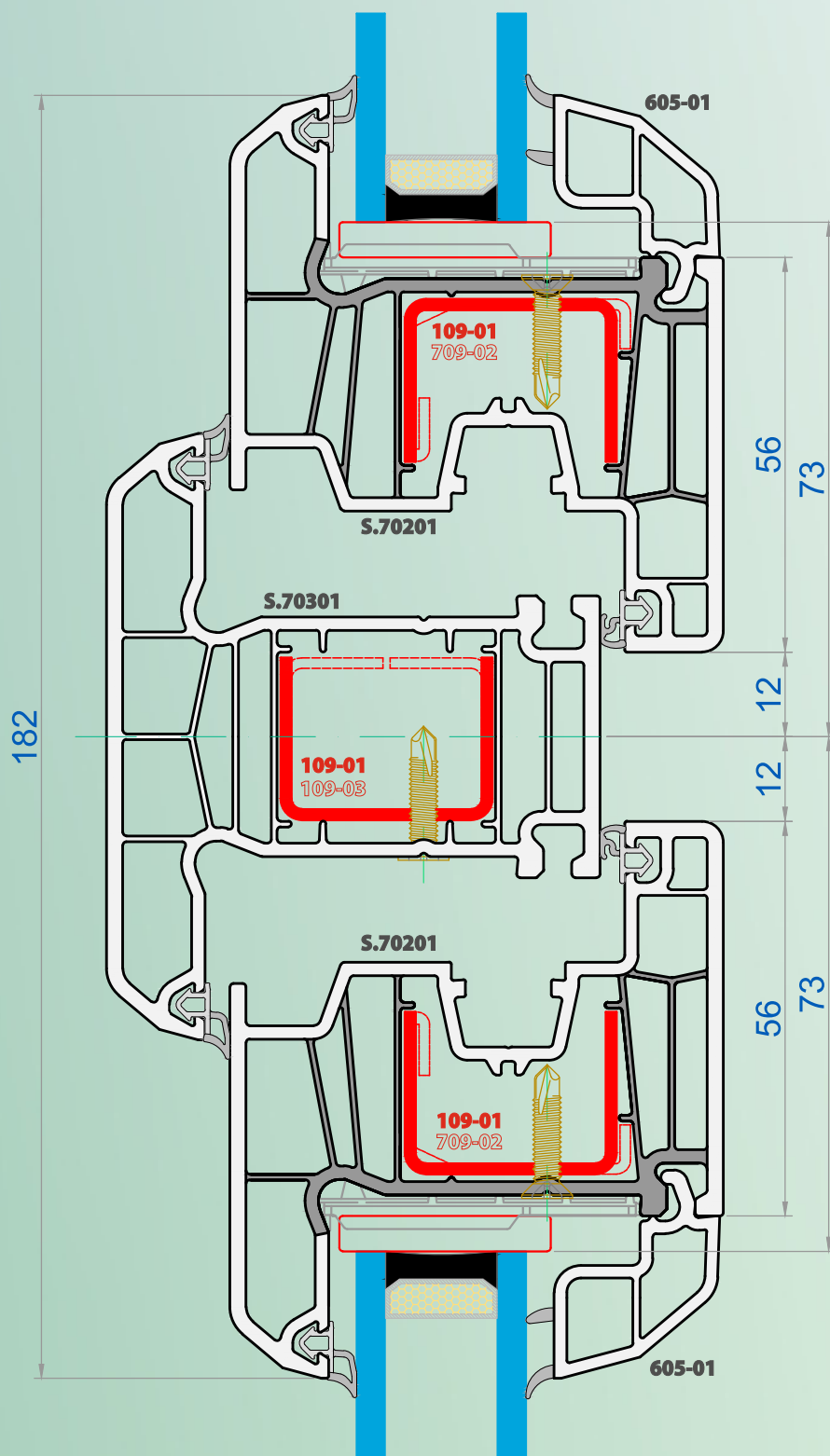
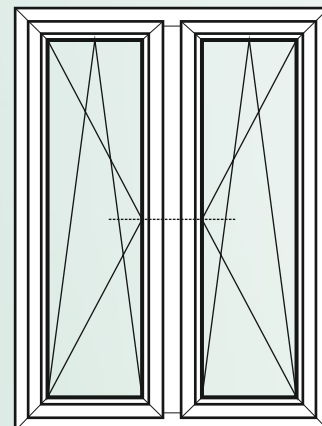



Cap.3 Combinatii de profile

Profil montant - **S.70301**  
Profil cercevea - **S.70202**

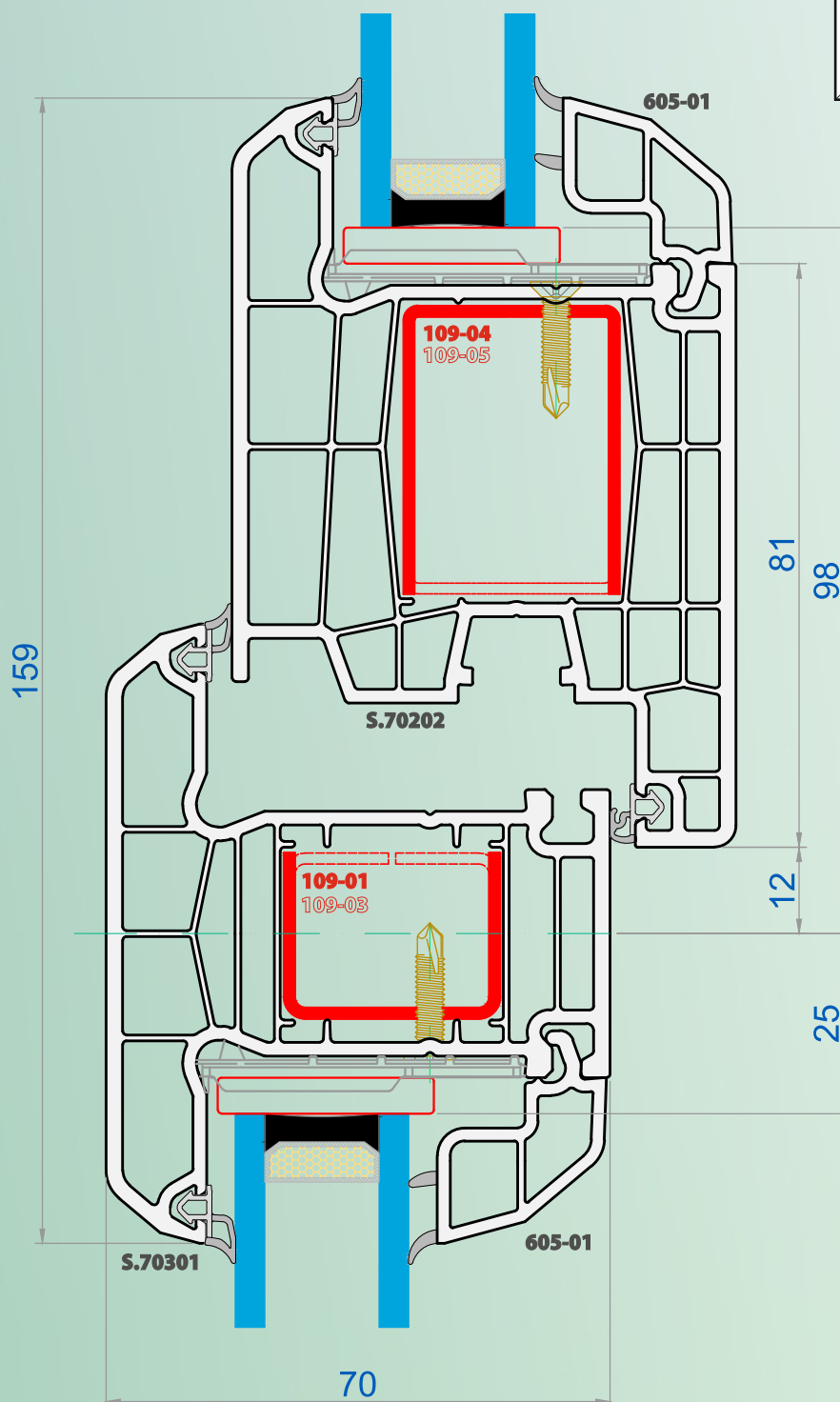
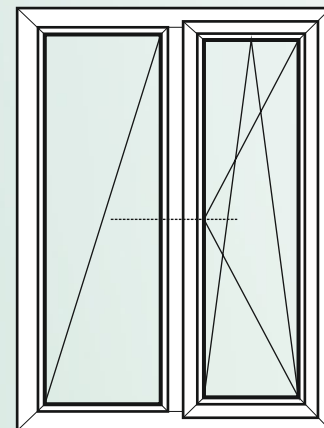

Cap.3 Combinatii de profile

- Profil montant - **S.70301**
- Profil cercevea - **S.70202**
- Profil cercevea - **S.70202**

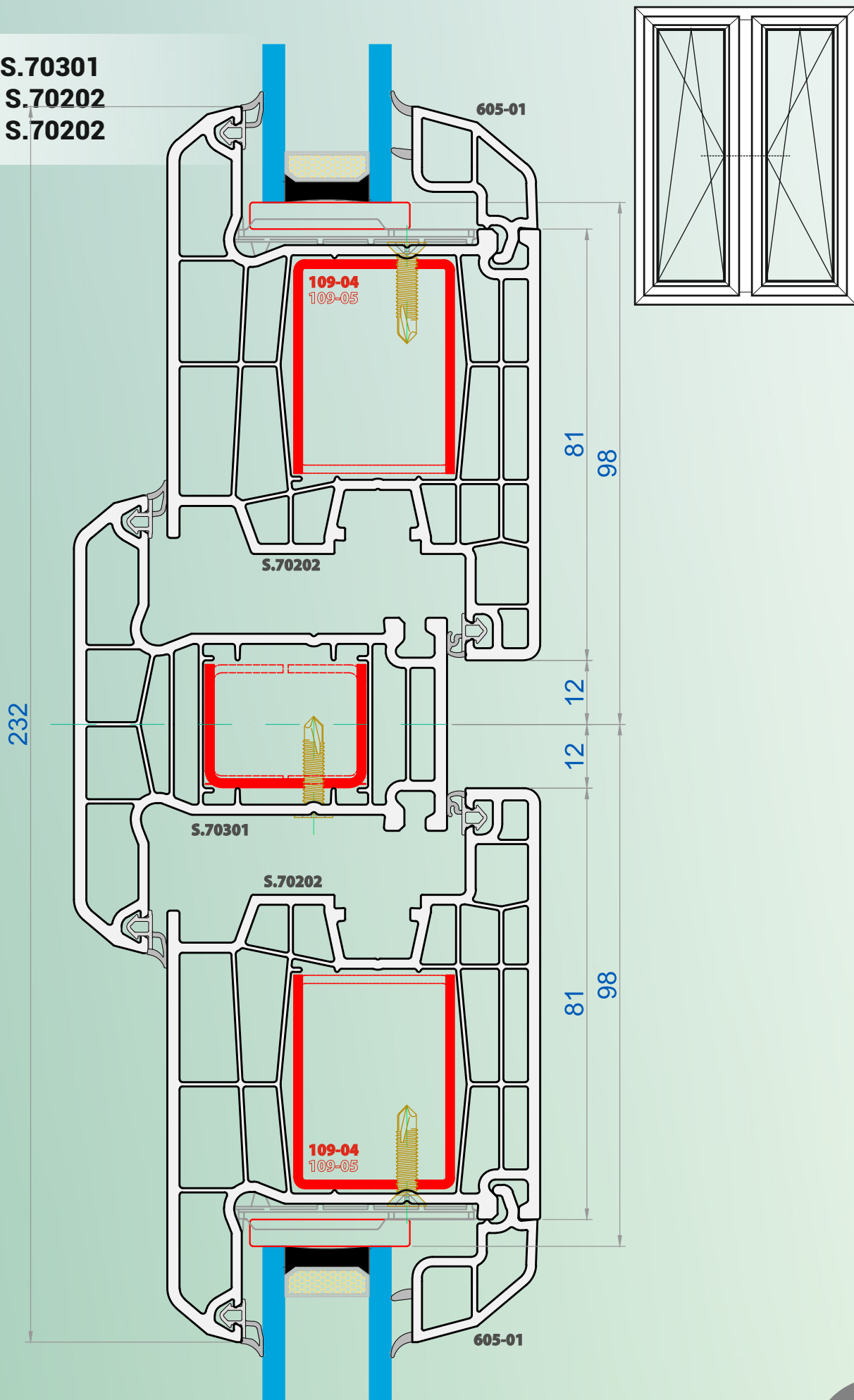

Cap.3 Combinatii de profile

- Profil montant - **S.70301**
- Profil cercevea - **S.70203**
- Profil cercevea - **S.70203**

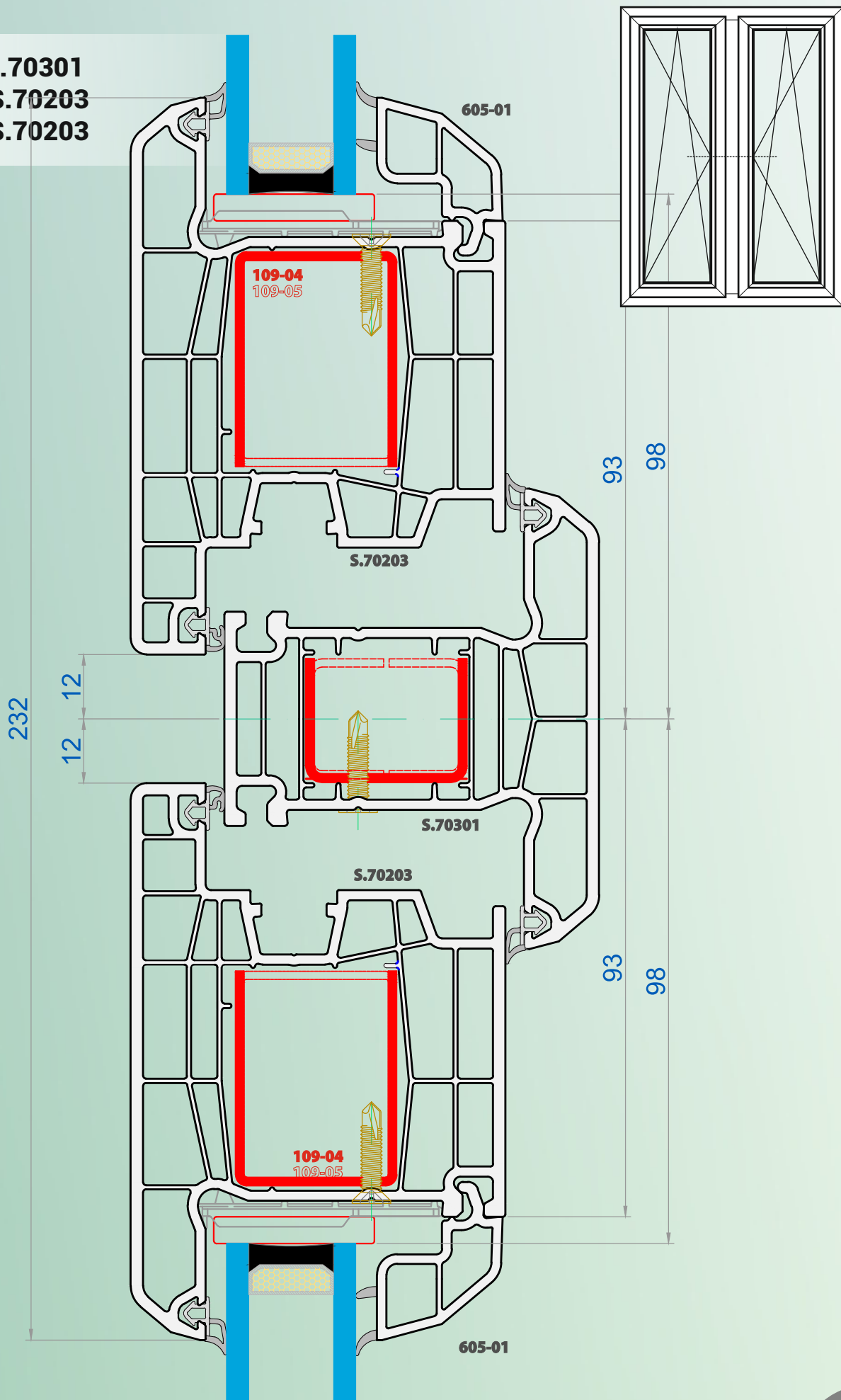

Cap.3 Combinatii de profile

Profil montant mobil - **S.70401**

Profil cercevea - **S.70201**

Profil cercevea - **S.70201**

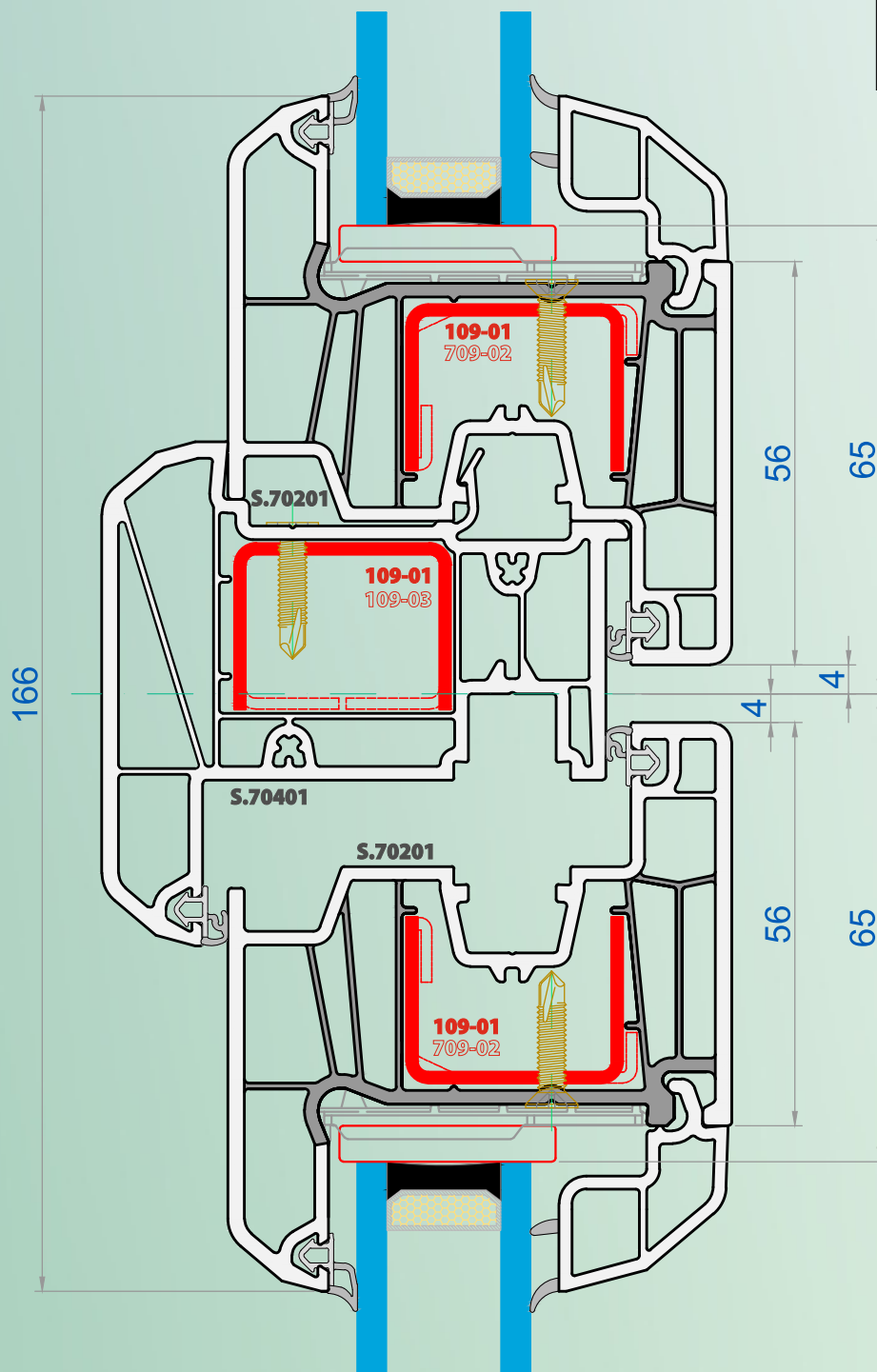
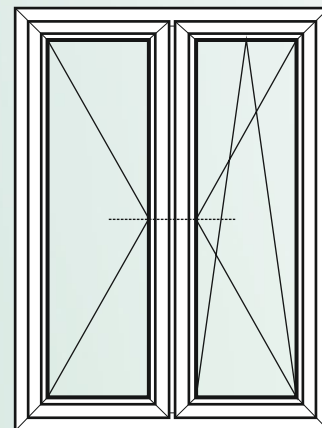

Cap.3 Combinatii de profile

Profil montant mobil - **S.70401**

Profil cercevea - **S.70202**

Profil cercevea - **S.70202**

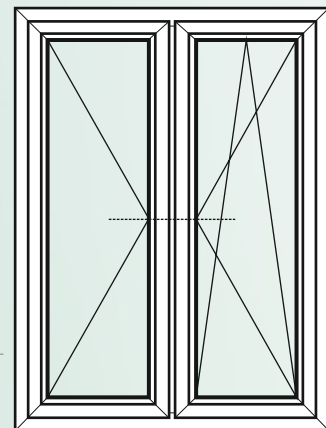
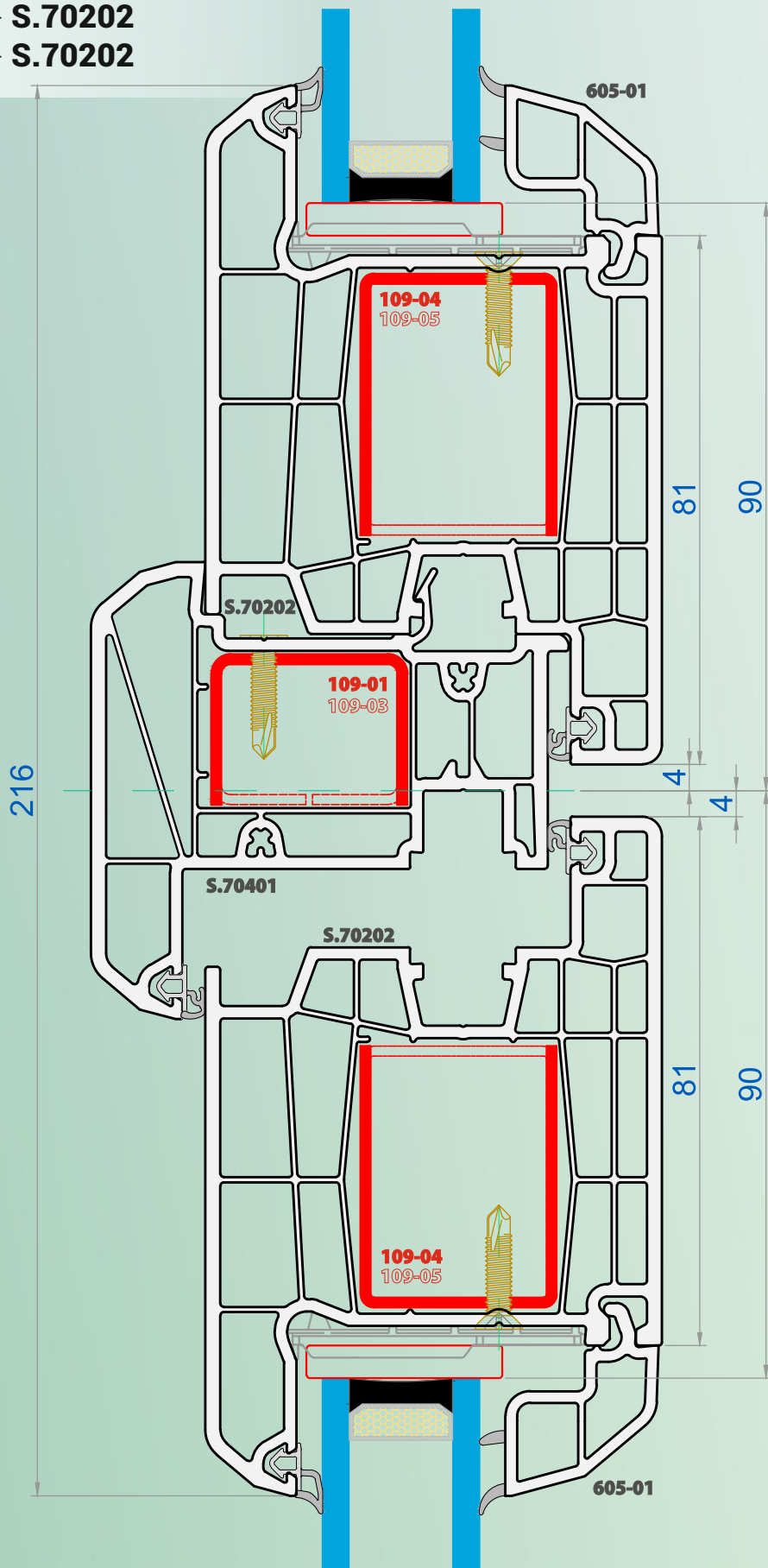

Cap.3 Combinatii de profile

Profil montant mobil - **S.70401**

Profil cercevea - **S.70203**

Profil cercevea - **S.70203**

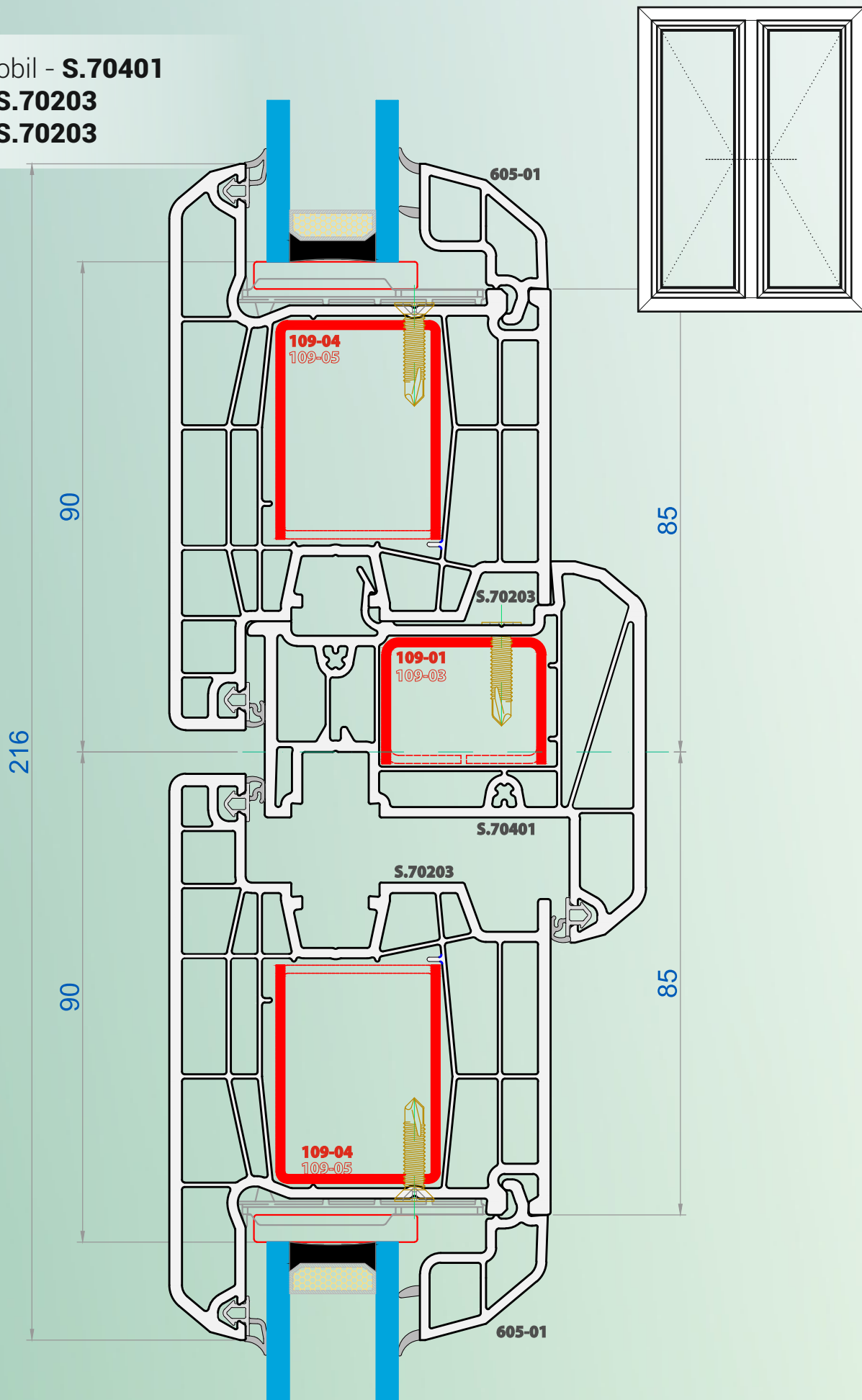

Cap.3 Combinatii de profile

Profil ramă - **S.70101**  
Profil cuplare - **306-01**

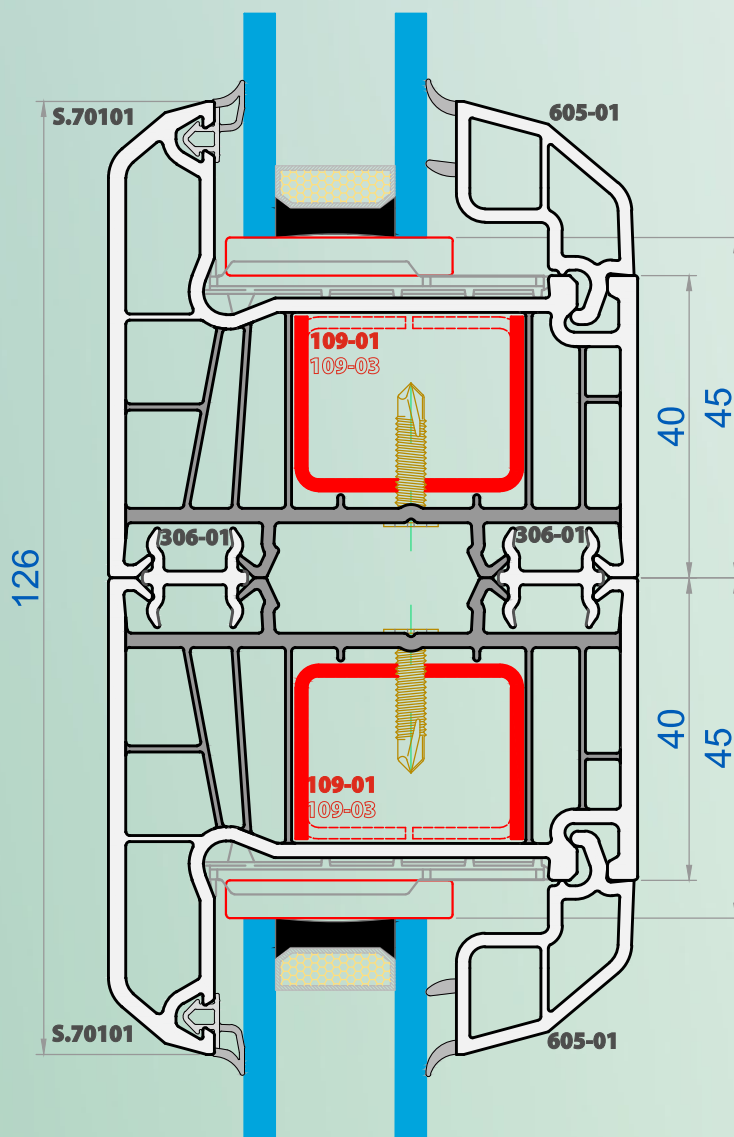
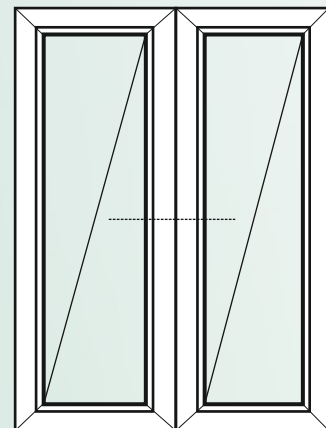

Cap.3 Combinatii de profile

Profil ramă - **S.70101**  
Profil cuplare - **606-01**

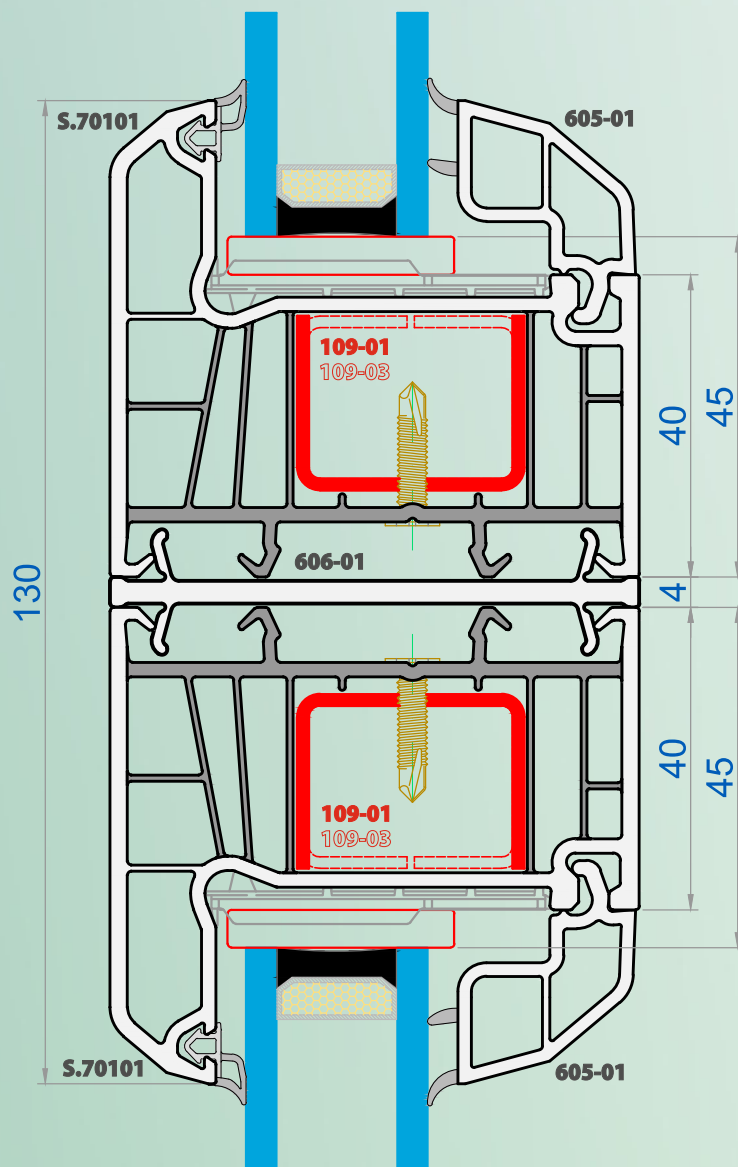
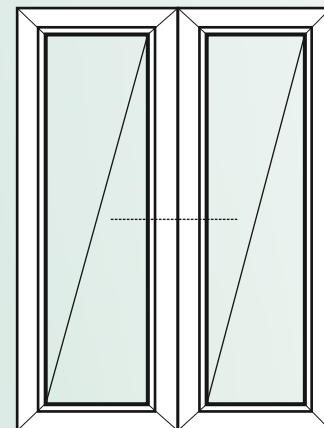



Cap.3 Combinatii de profile

Profil ramă - **S.70101**  
Profil cuplare - **206-02**

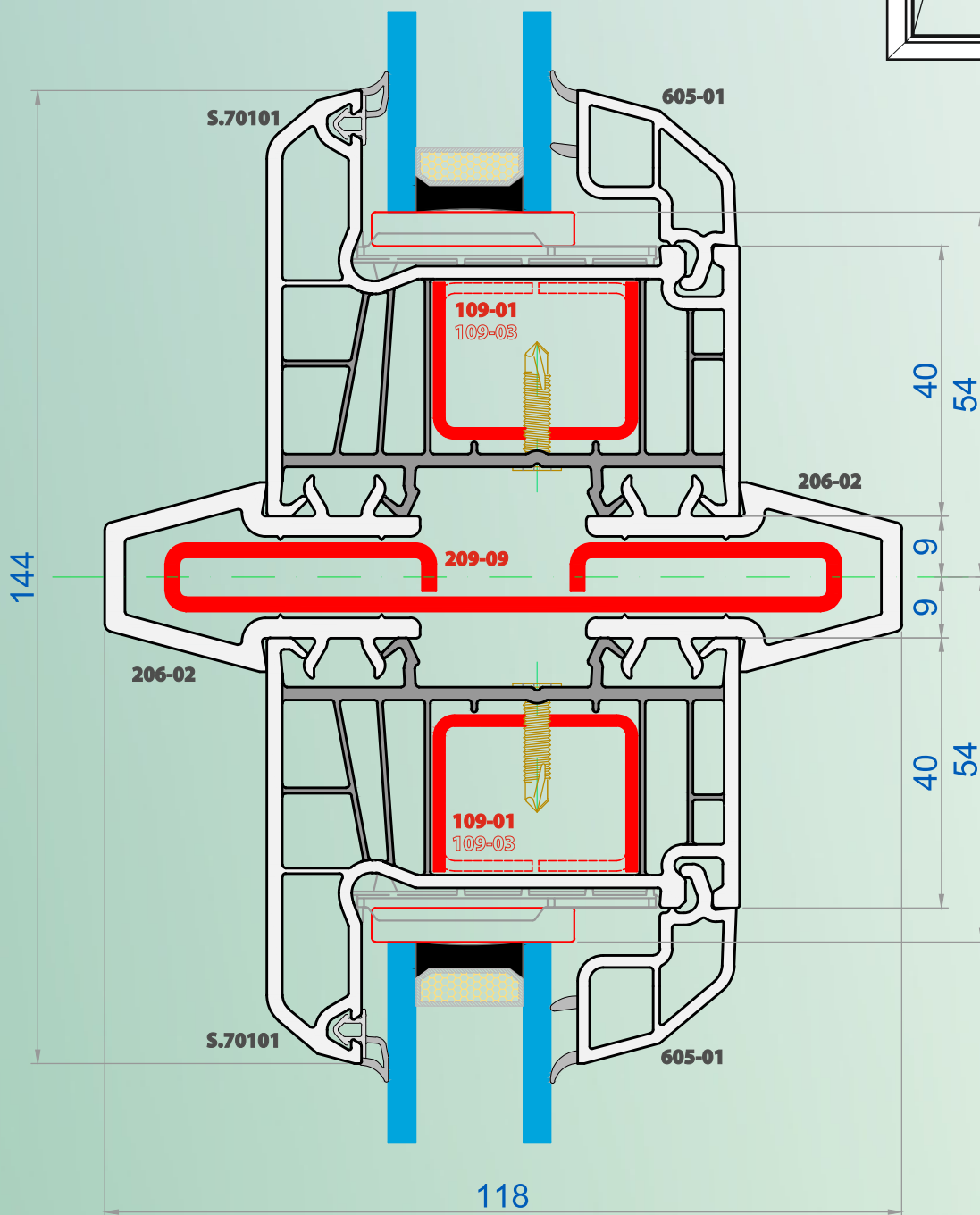
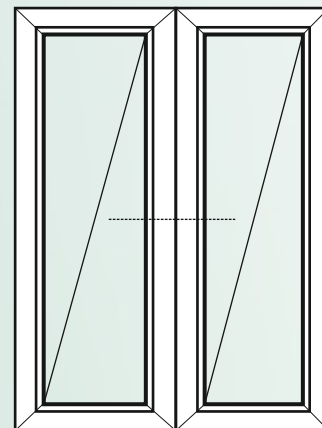

Cap.3 Combinatii de profile

Profil ramă - **S.70101**  
Profil cuplare - **206-02**

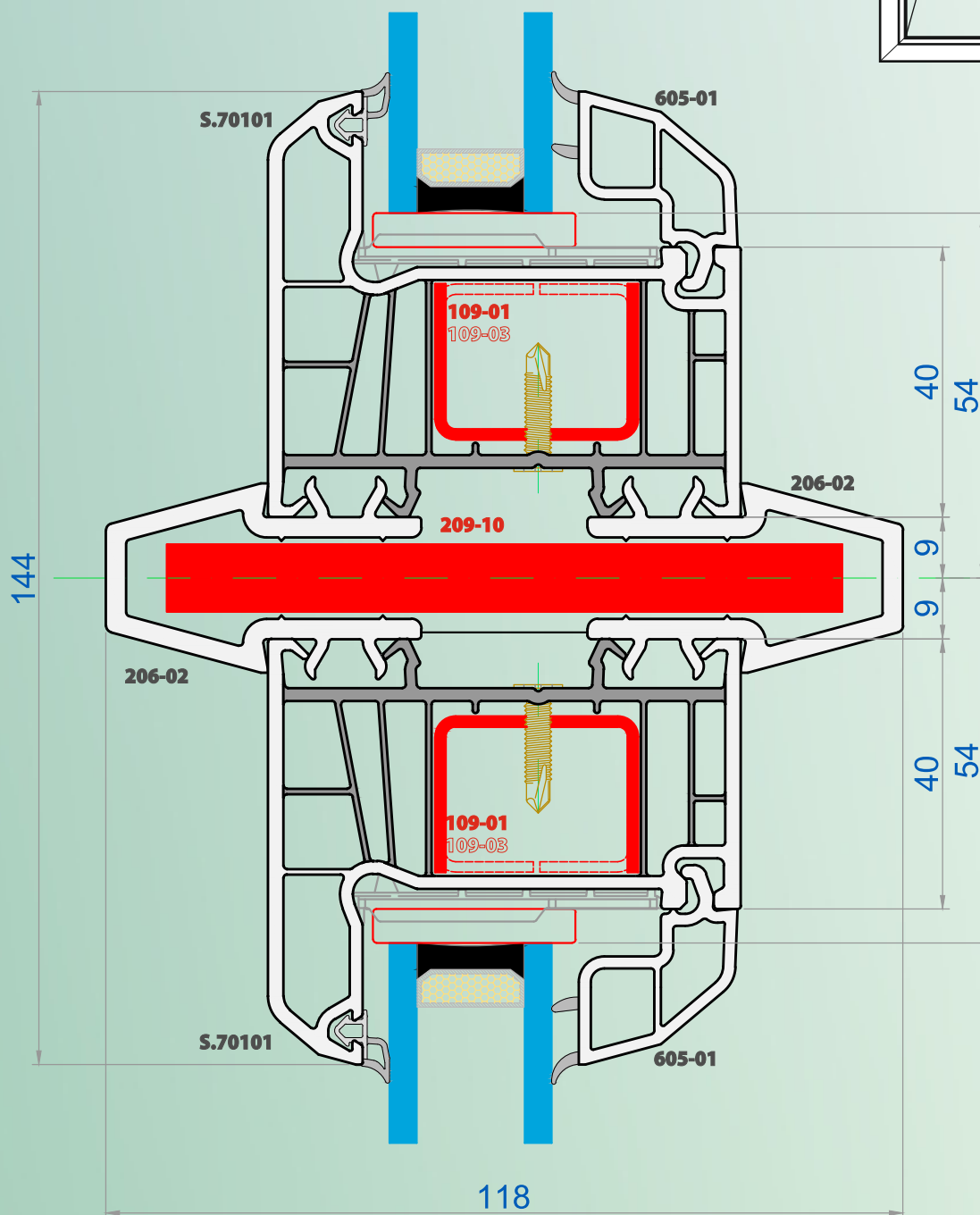
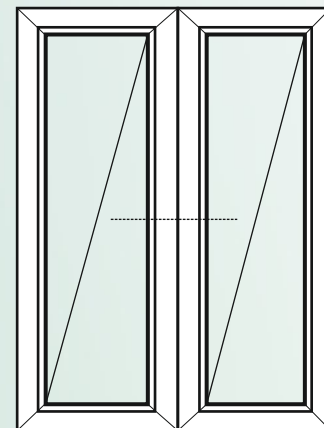

Cap.3 Combinatii de profile

Profil ramă - **S.70101**

Profil teavă - **606-03**

Profil adaptor teava - **306-04**

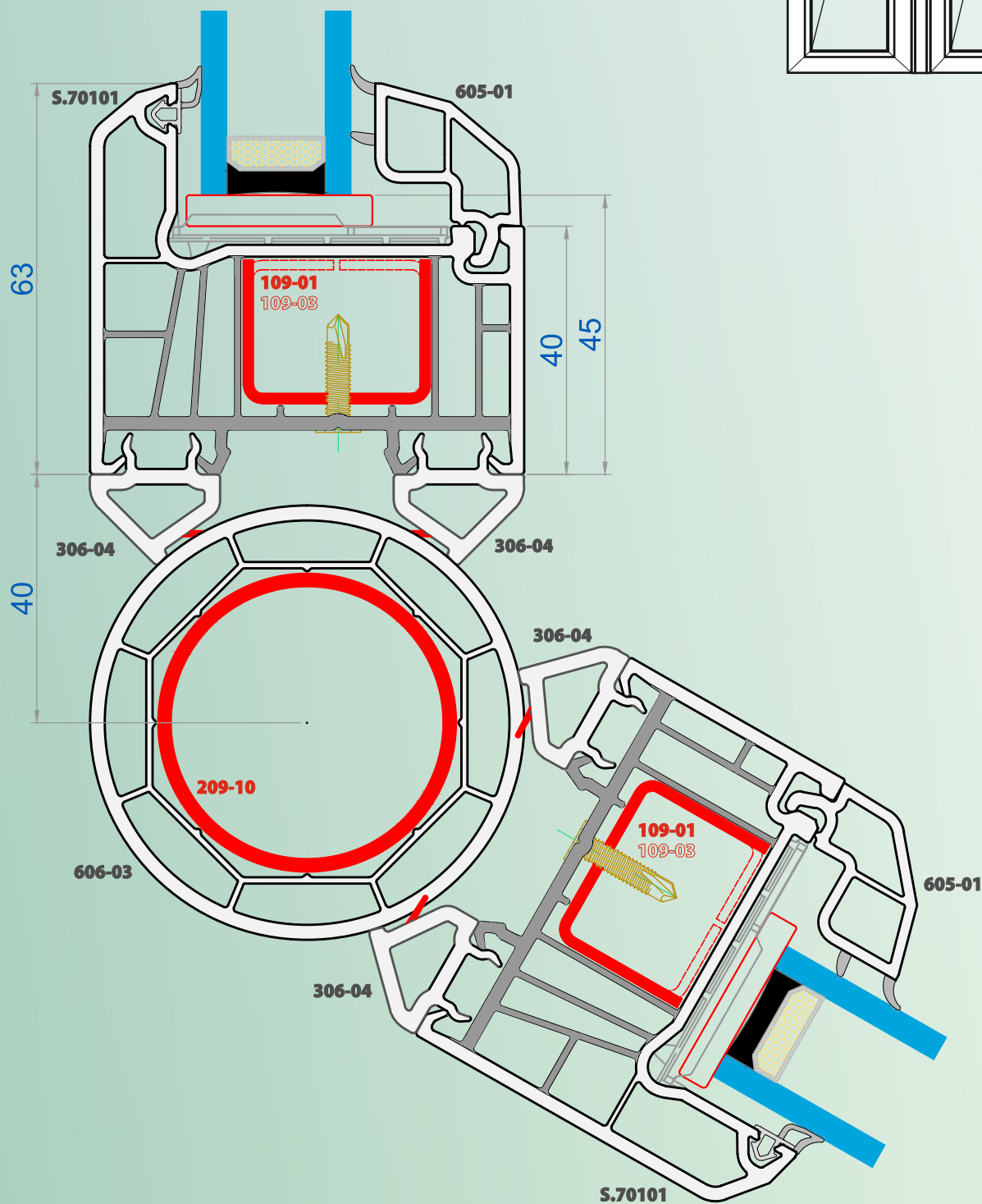
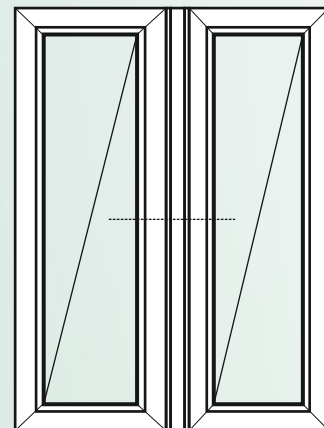

Cap.3 Combinatii de profile

Profil ramă - **S.70101**

Profil teavă - **606-03**

Profil adaptor teava - **606-04**

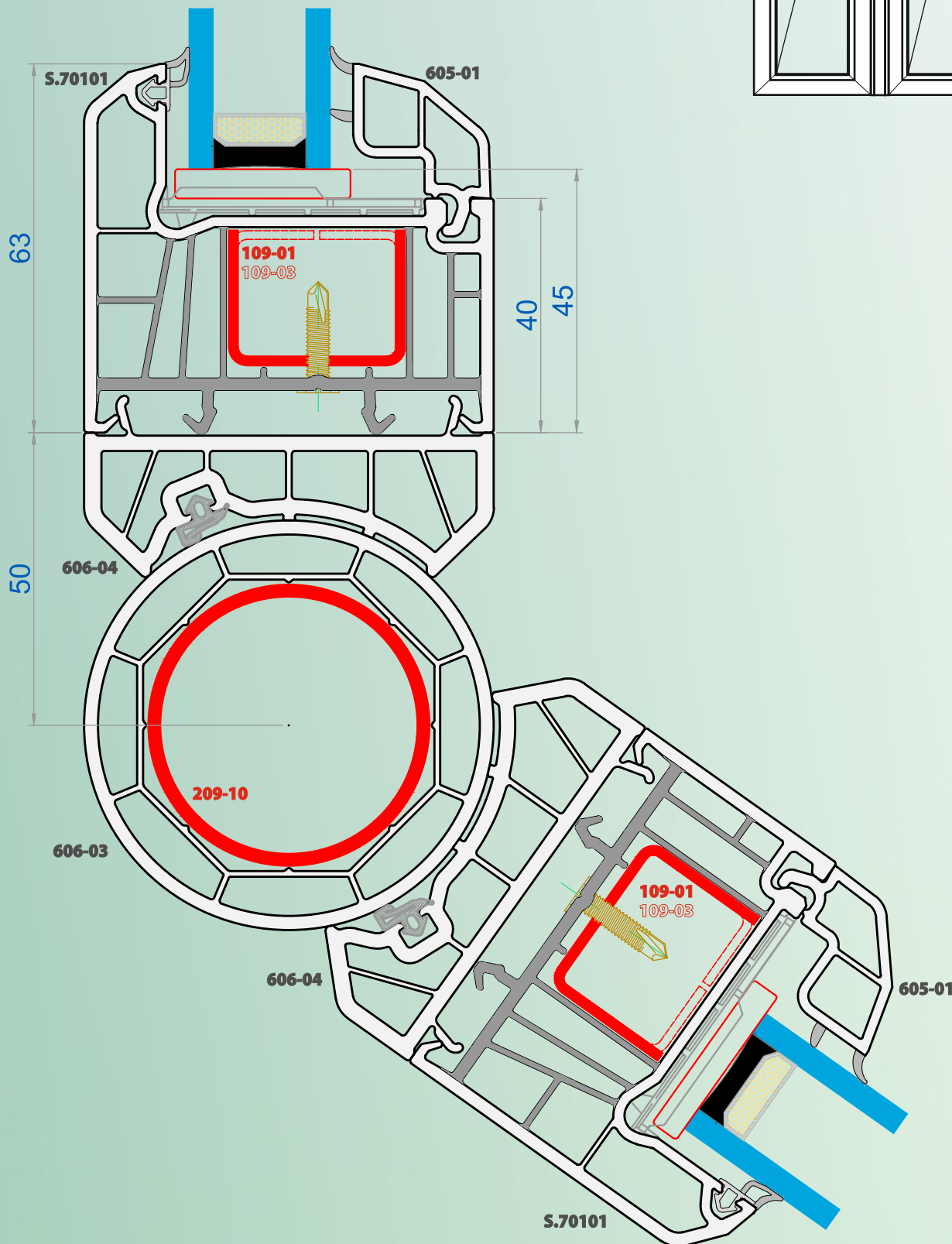
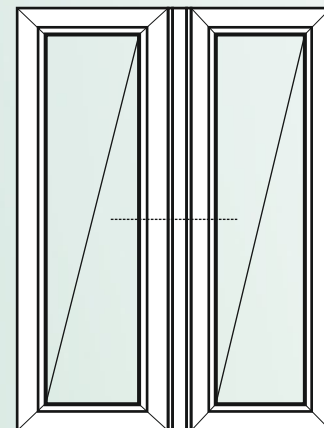

Cap.3 Combinatii de profile

Profil ramă - **S.70101**

Profil cuplare 90°- **606-05**

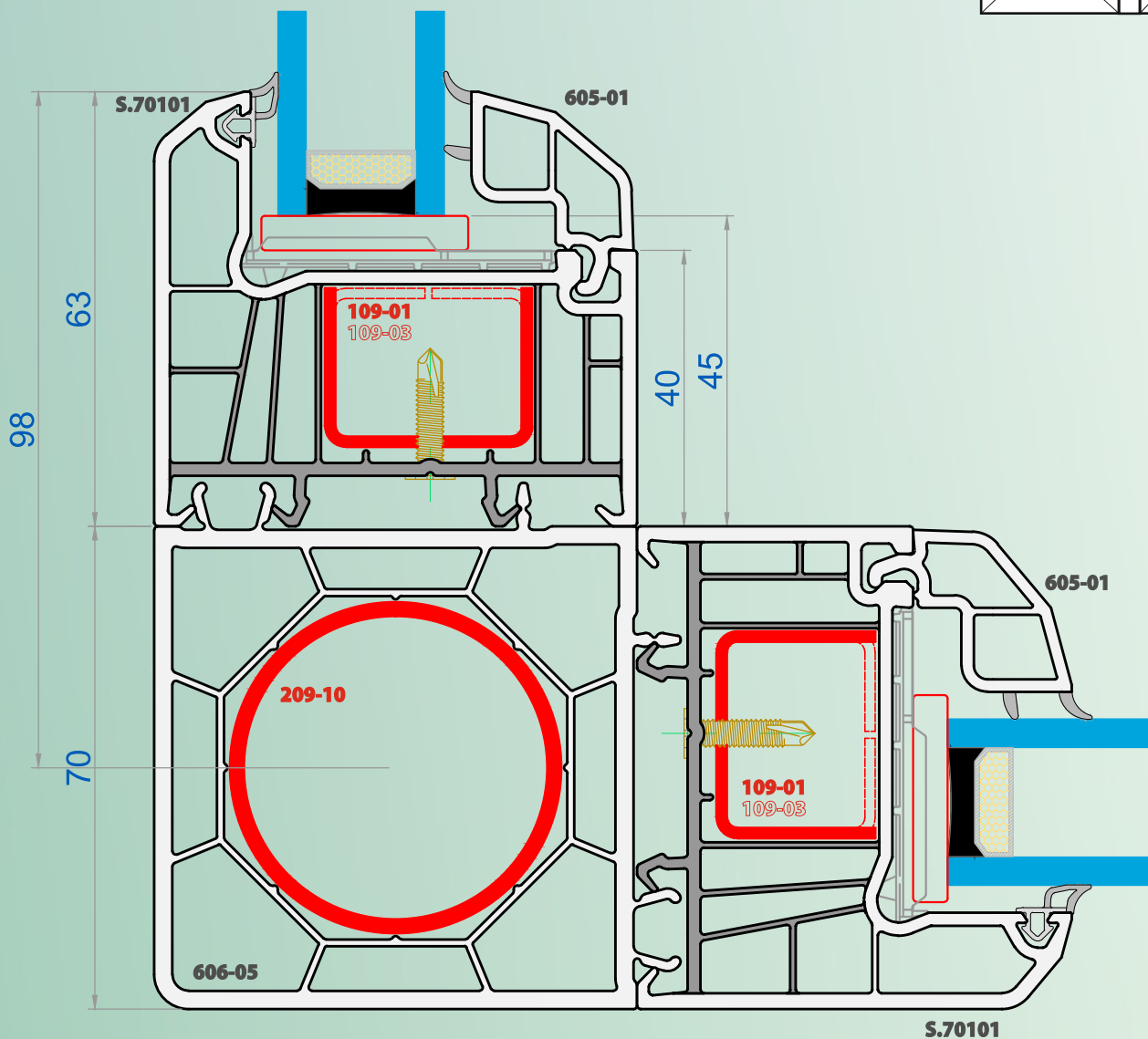
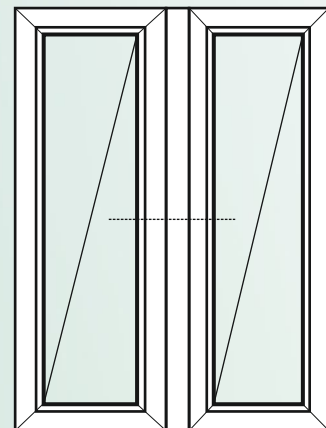

Cap.3 Combinatii de profile

Profil ramă - **S.70101**  
Profil cuplare - **606-06**

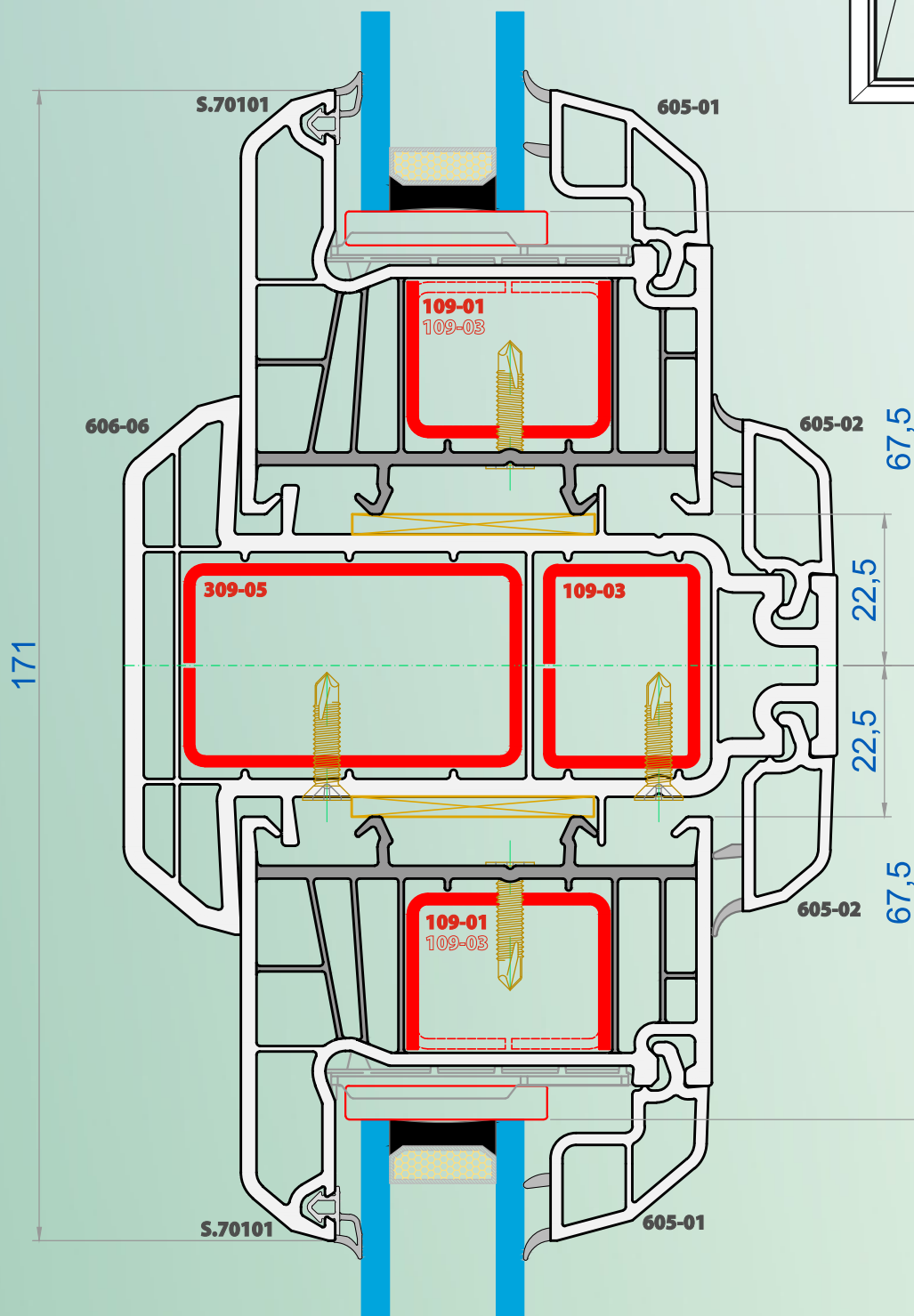
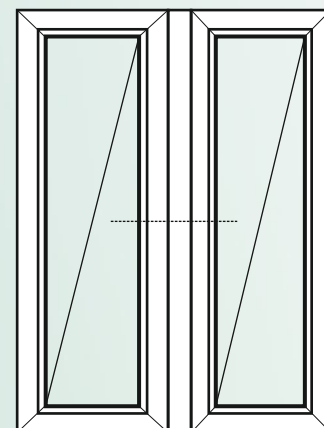

Cap.3 Combinatii de profile

- Profil ramă - **S.70101**
- Profil adăugare ramă - **607-01**
- Profil cuplare - **606-06**

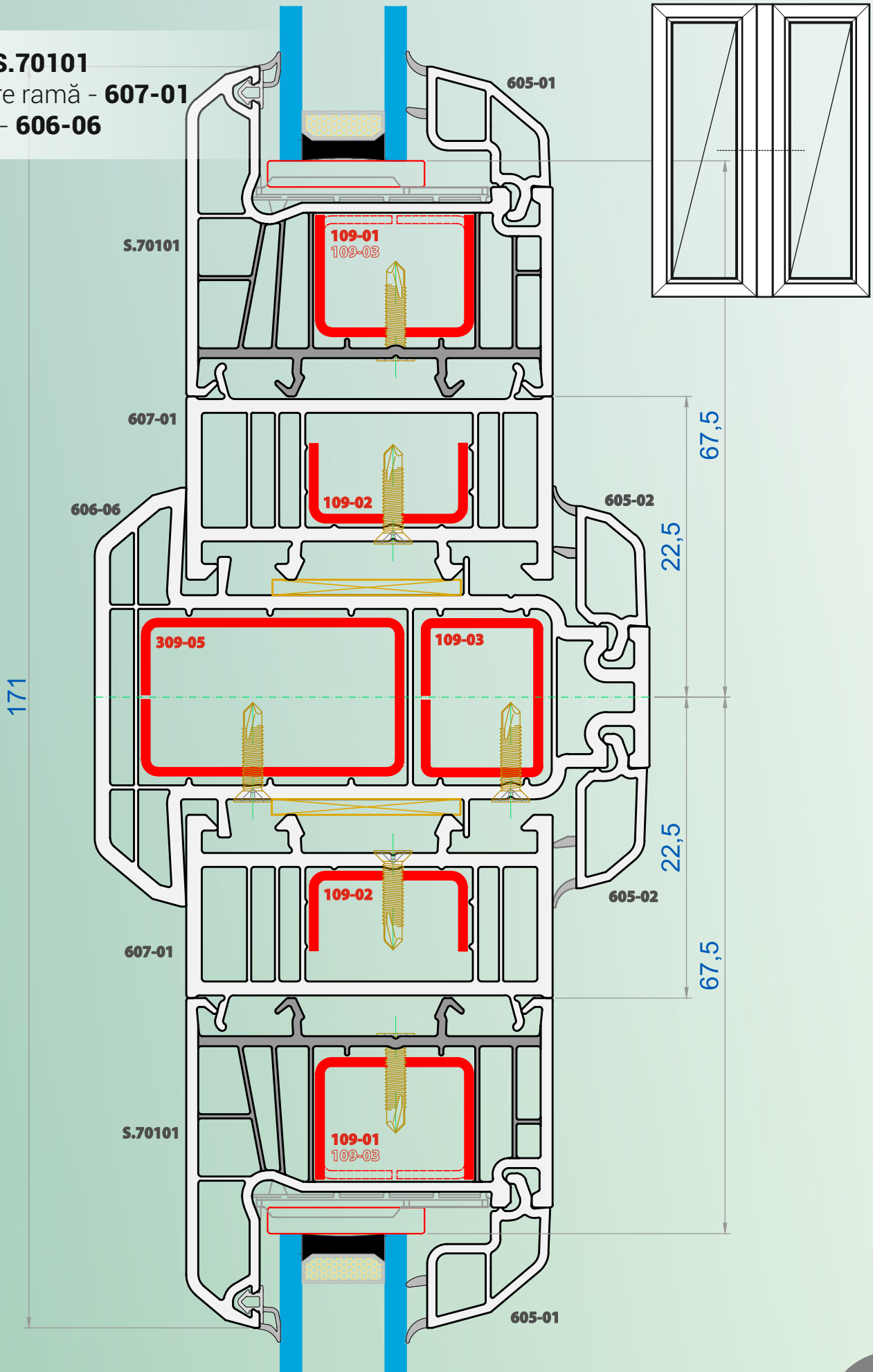

Cap.3 Combinatii de profile

Profil montant - **S.70301**

Profil rigidizare montant - **607-02**

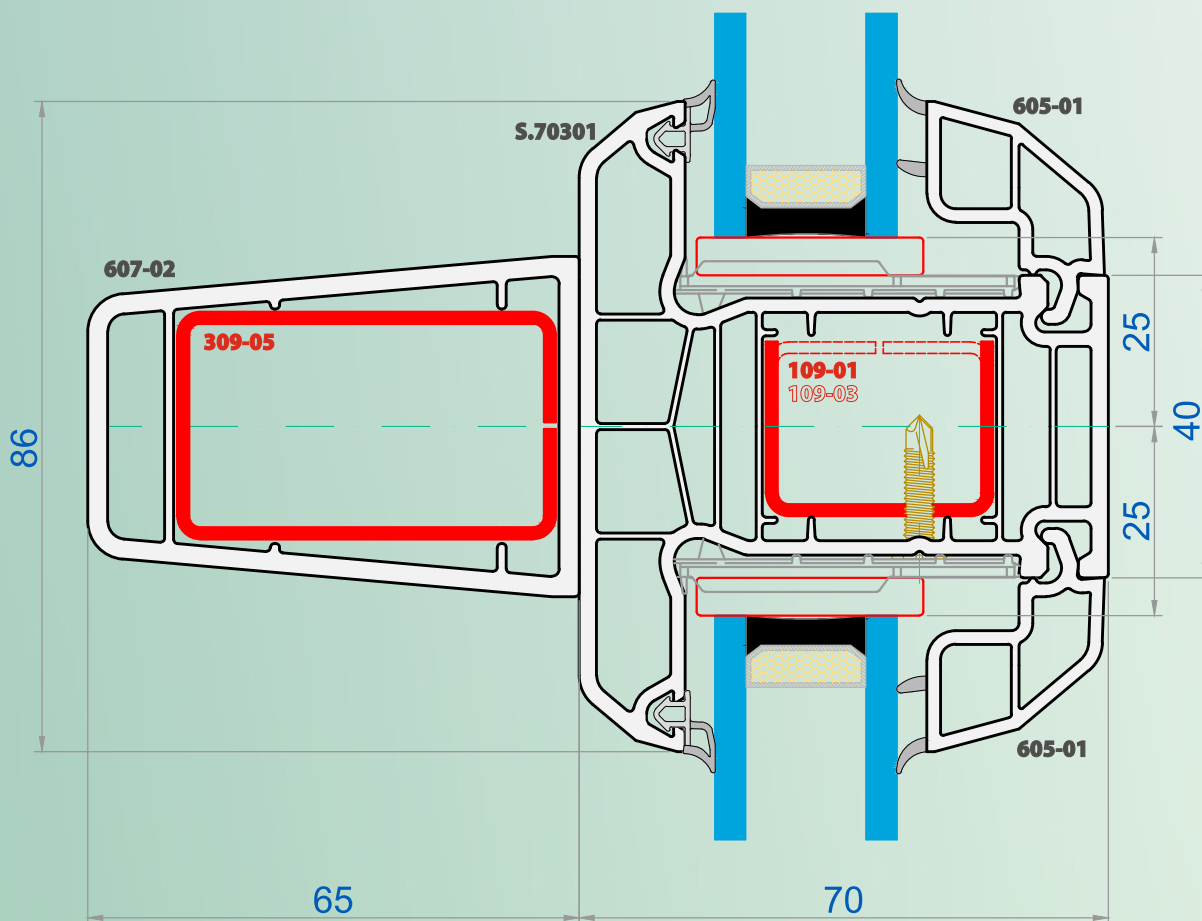
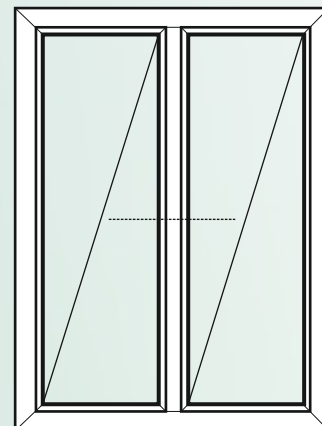



Cap.3 Combinatii de profile

Profil ramă - **S.70101**

Profil cuplare - **606-06**

Profil rigidizare montant - **607-02**

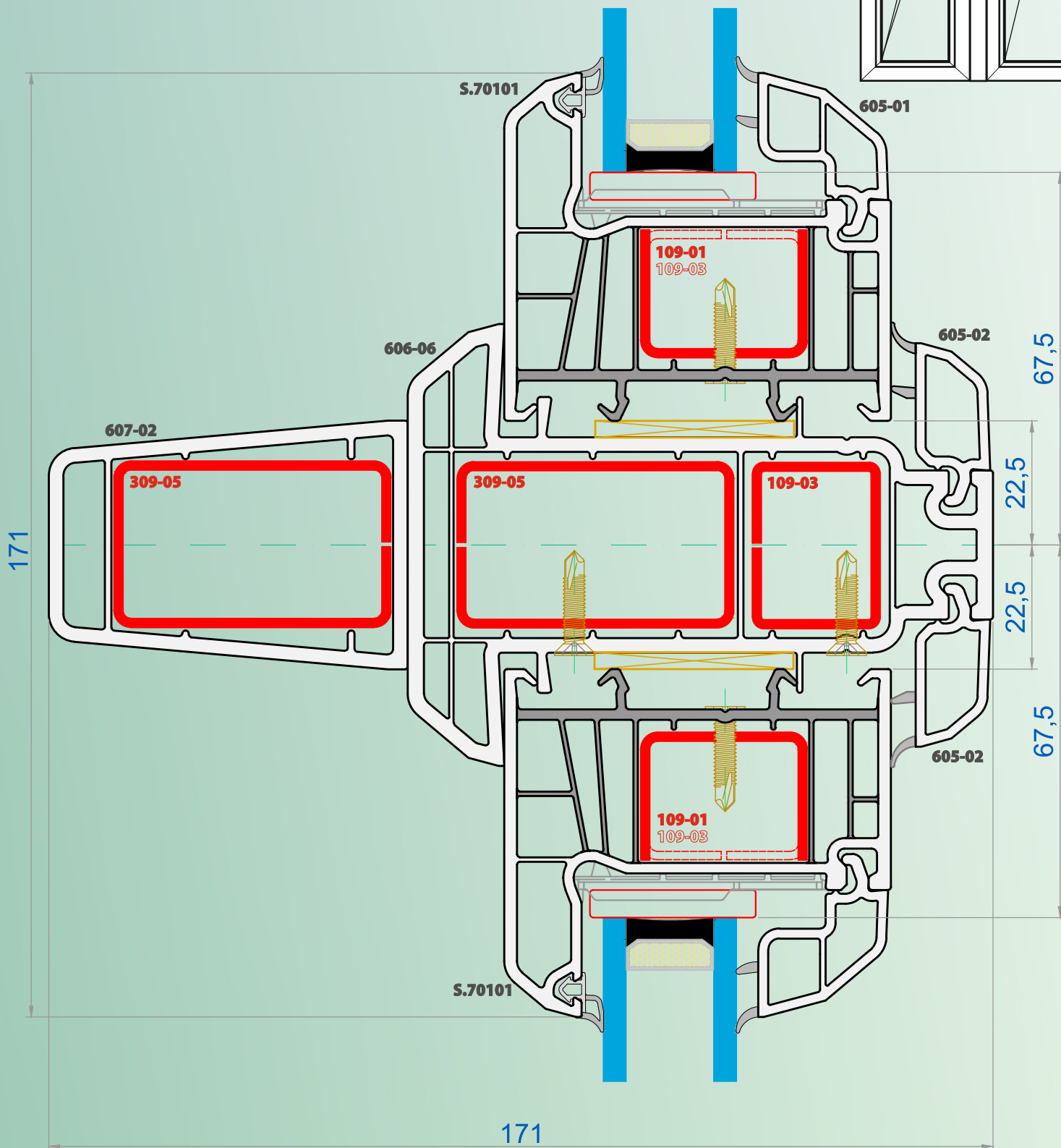
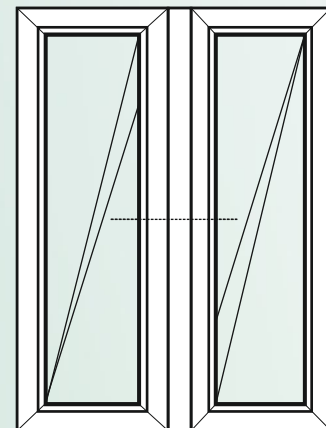

Cap.3 Combinatii de profile

Profil ramă - **S.70101**

Profil adăugare ramă - **607-01**

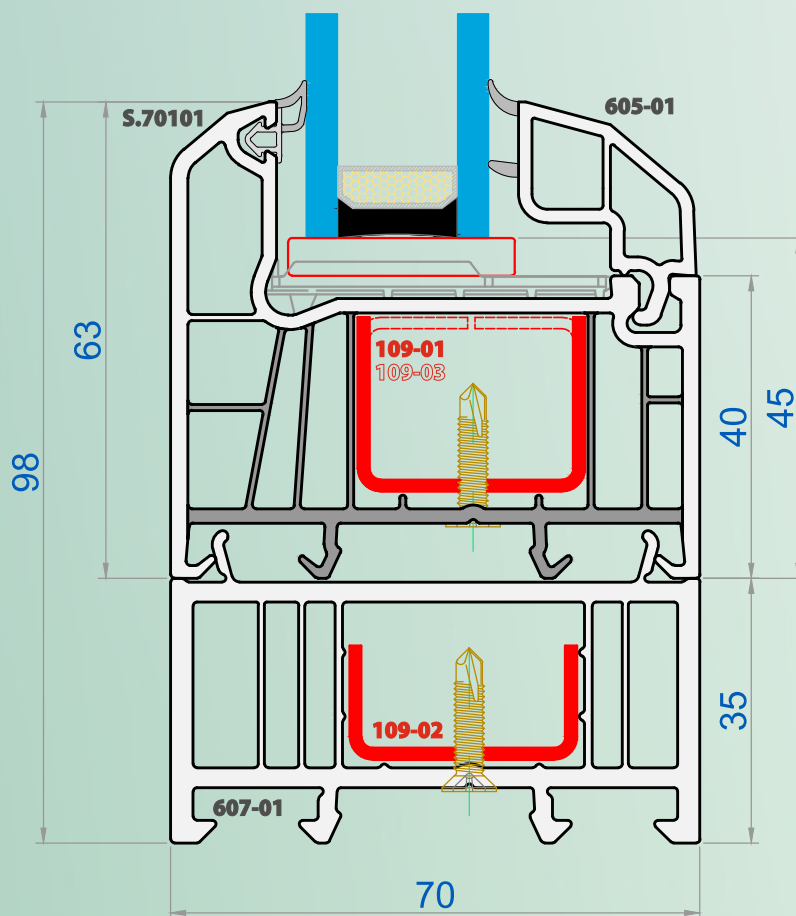
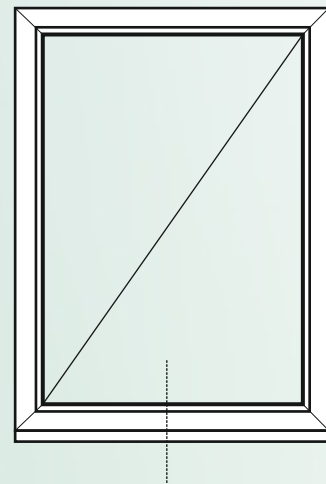

Cap.3 Combinatii de profile

Profil rama - **S.70101**

Profil cercevea - **S.70201**

Profil conector zid - **207-02**

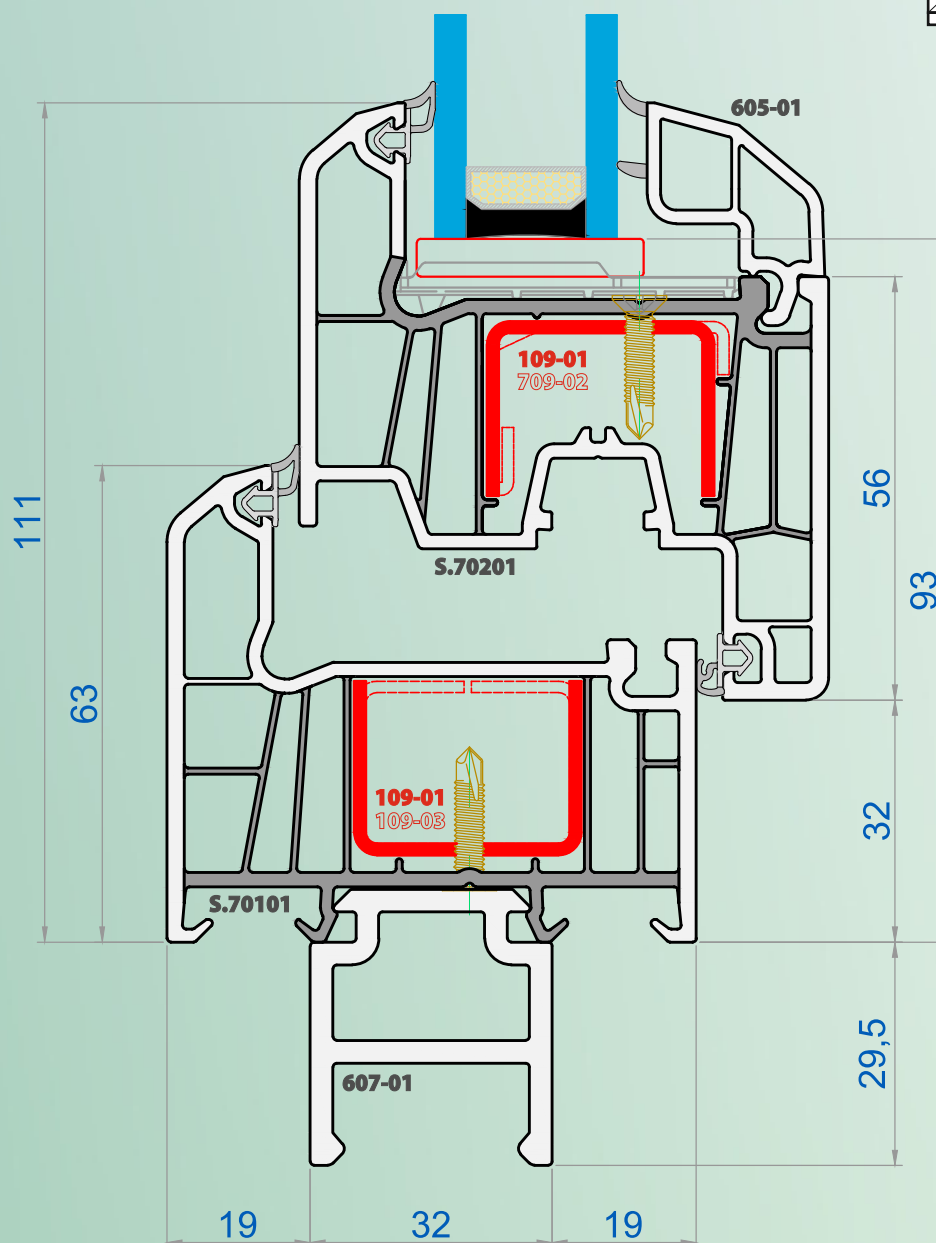
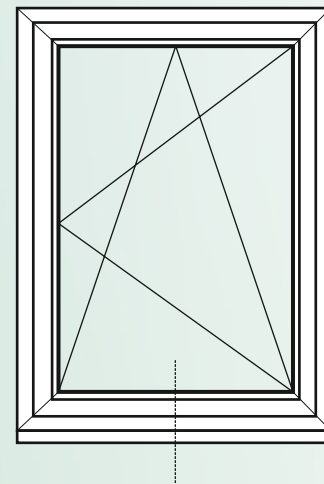

Cap.3 Combinatii de profile

- Profil rama - **S.70101**
- Profil cercevea - **S.70201**
- Profil picurător - **607-03**

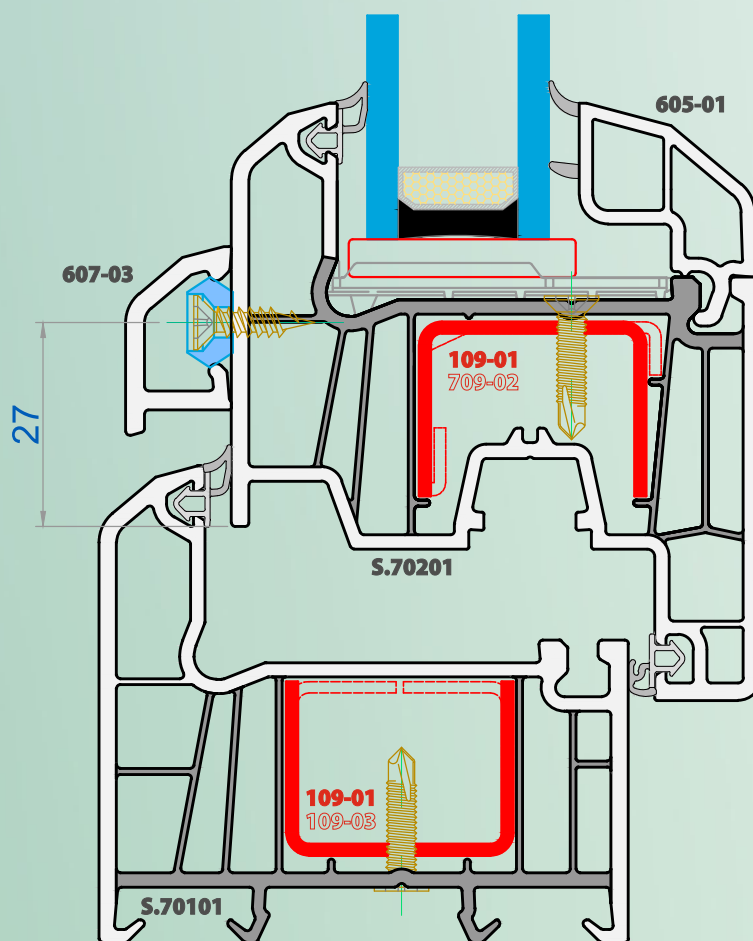
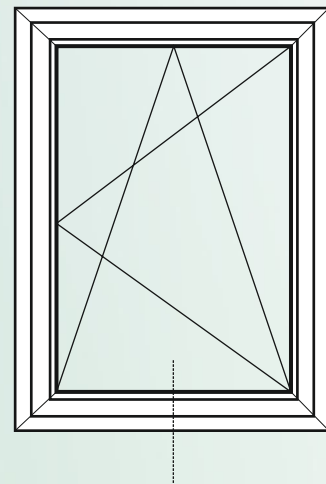

Cap.3 Combinatii de profile

Profil rama - **S.70101**

Profil cercevea - **S.70201**

Profil baghetă ornamentală - **607-04**

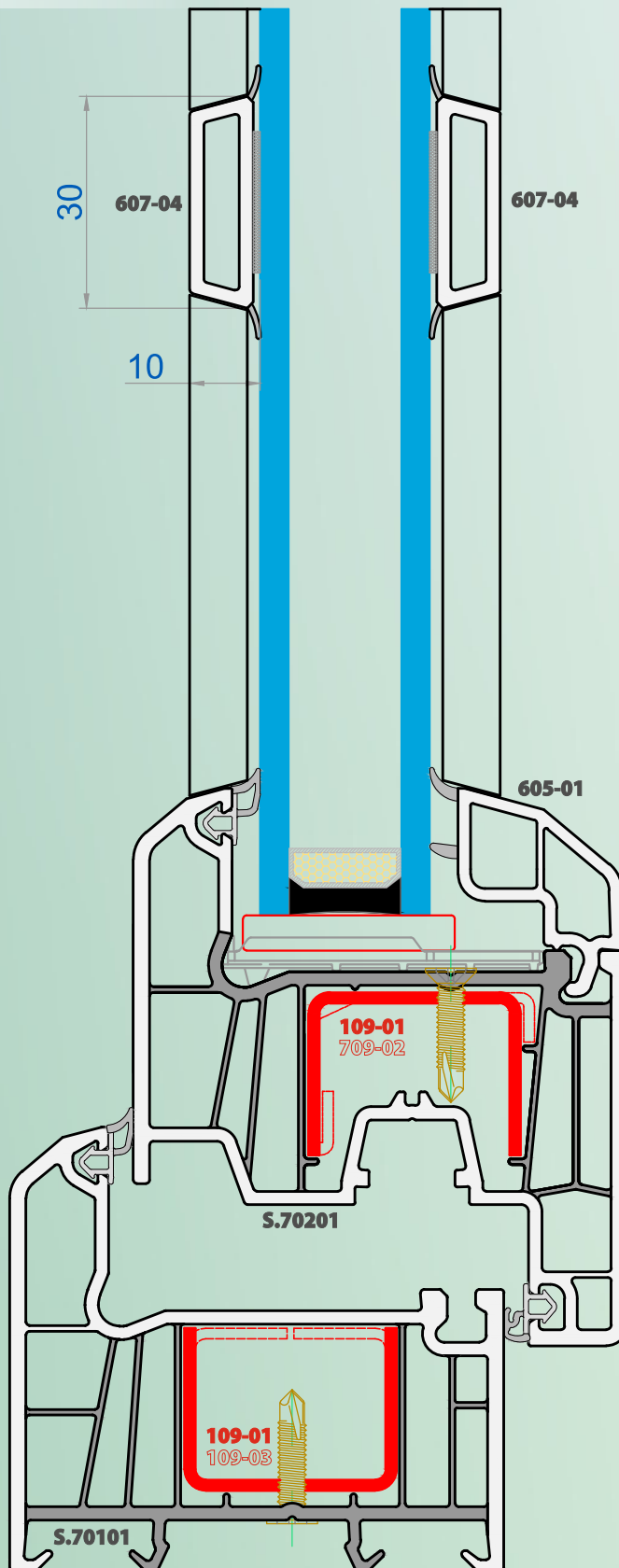
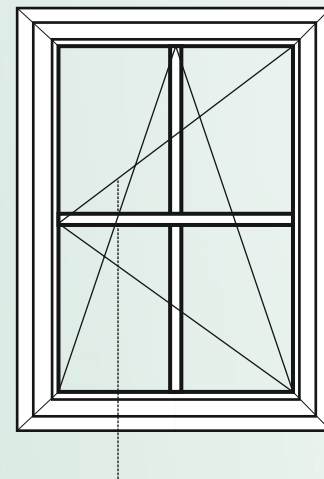

Cap.3 Combinatii de profile

- Profil rama - **S.70101**
- Profil cercevea - **S.70201**
- Profil pervaz - **607-06**

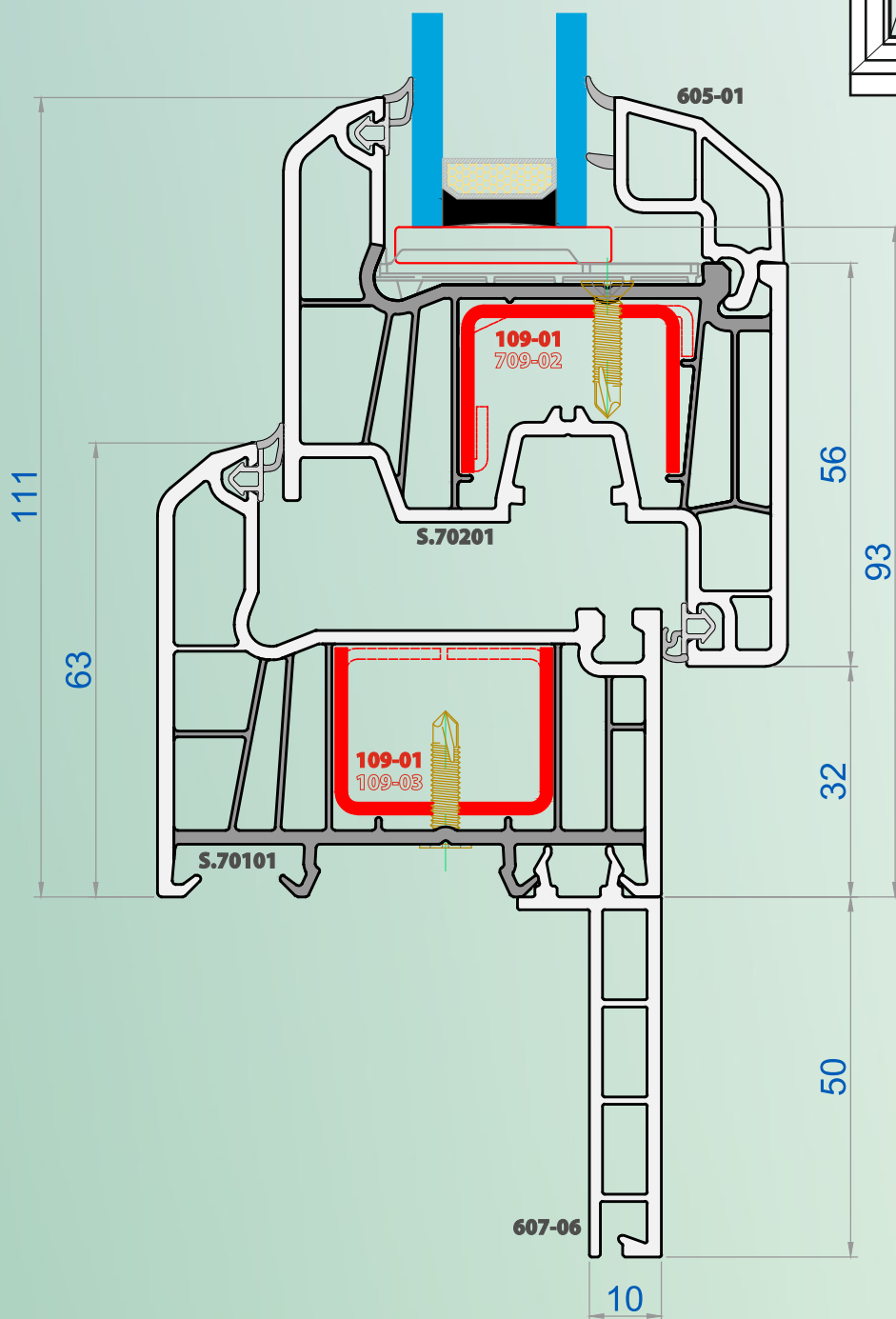
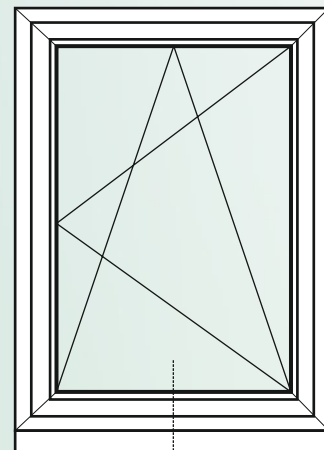

Cap.3 Combinatii de profile

- Profil rama - **S.70101**
- Profil cercevea - **S.70201**
- Profil pervaz - **607-06**

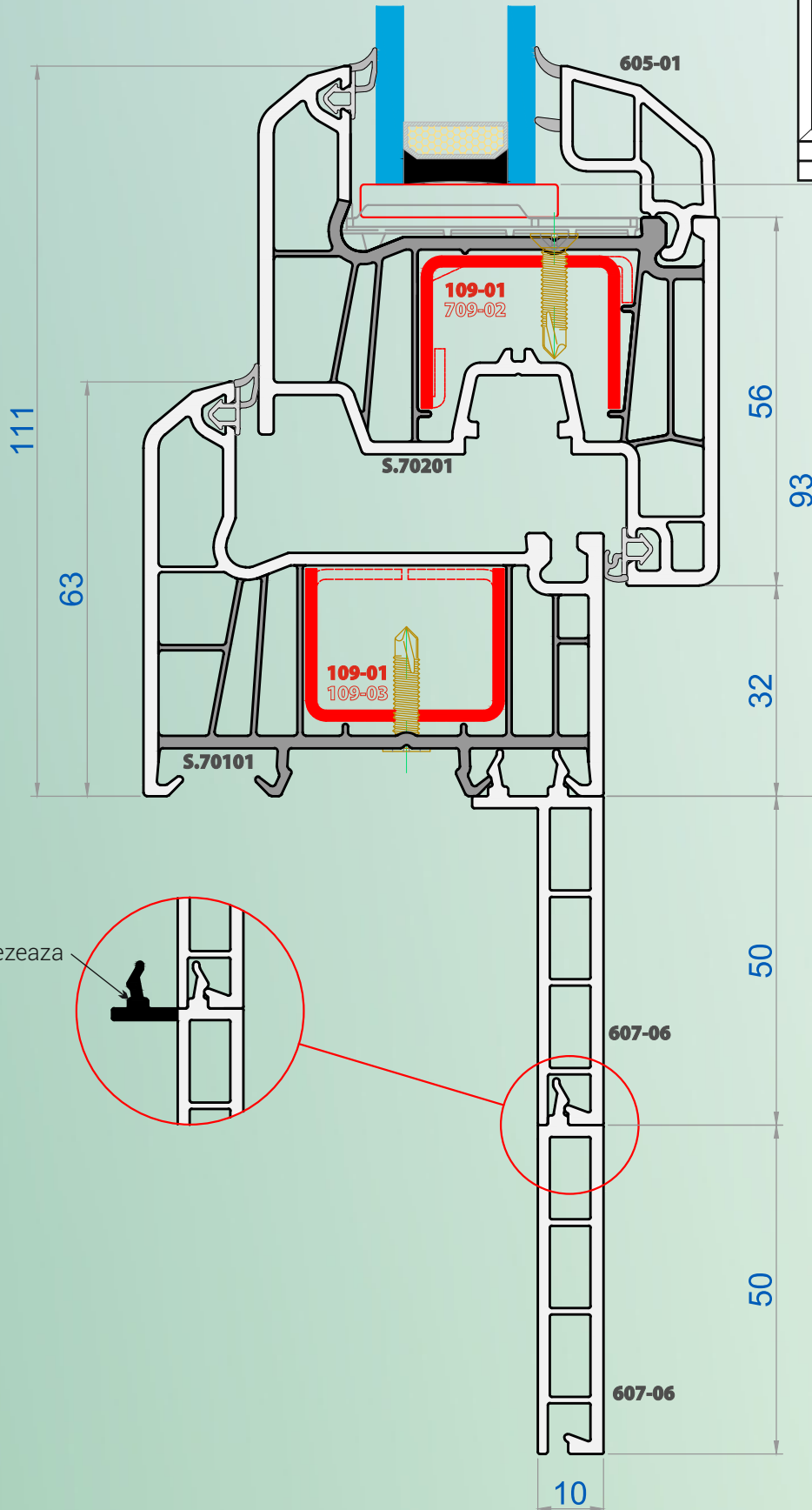
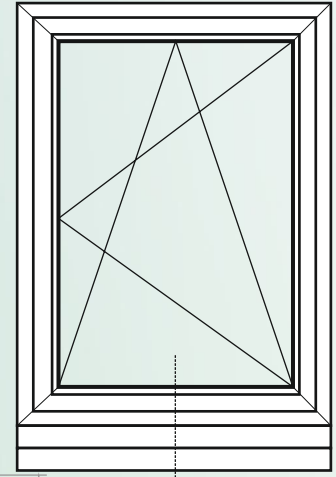

Portiune ce se frezeaza

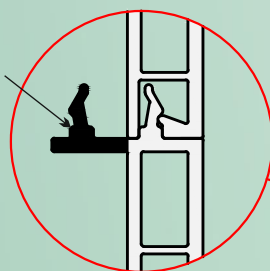

Cap.3 Combinatii de profile - serii complementare

Profil rama - **S.70101**  
Profil cercevea - **602-04**

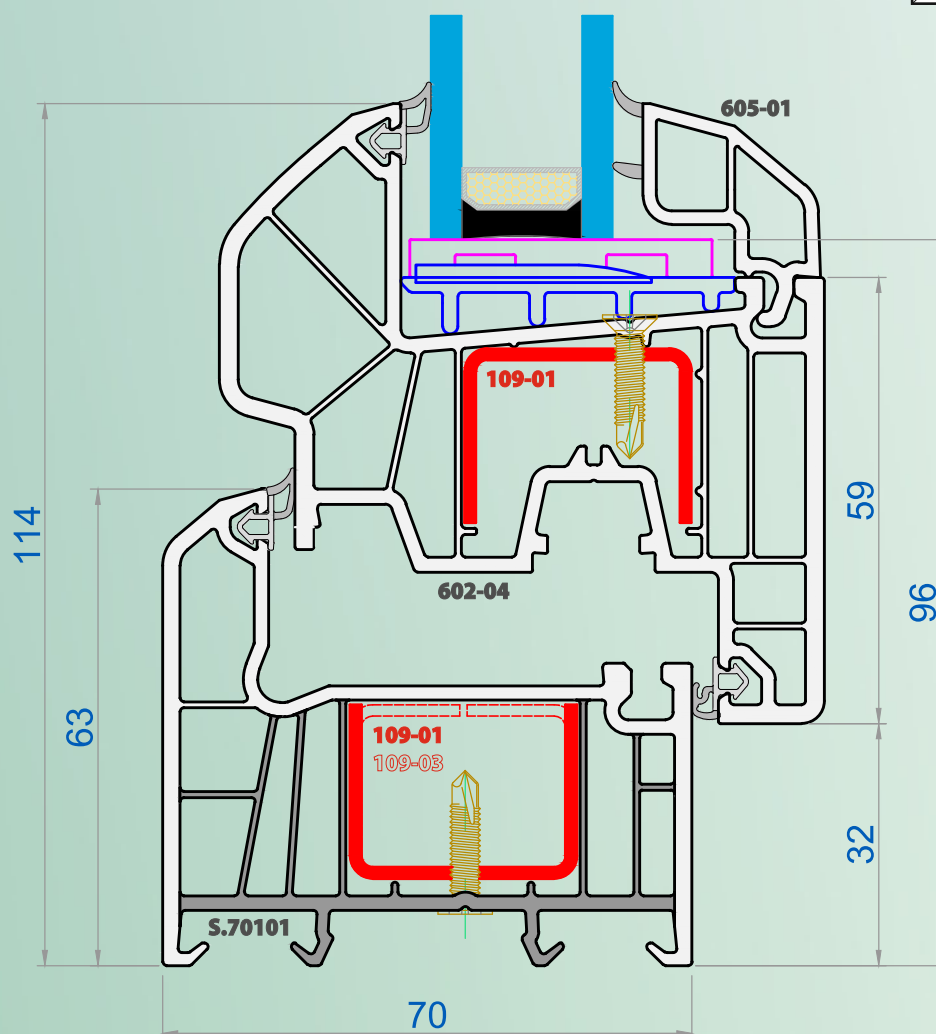
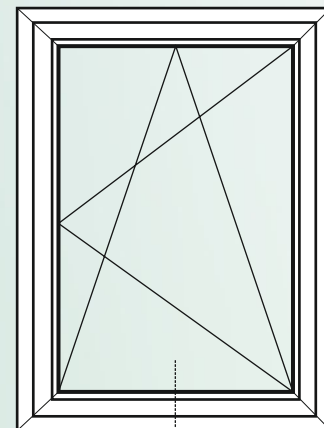



Cap.3 Combinatii de profile - serii complementare

Profil rama - **601-02**

Profil cercevea - **S.70201**

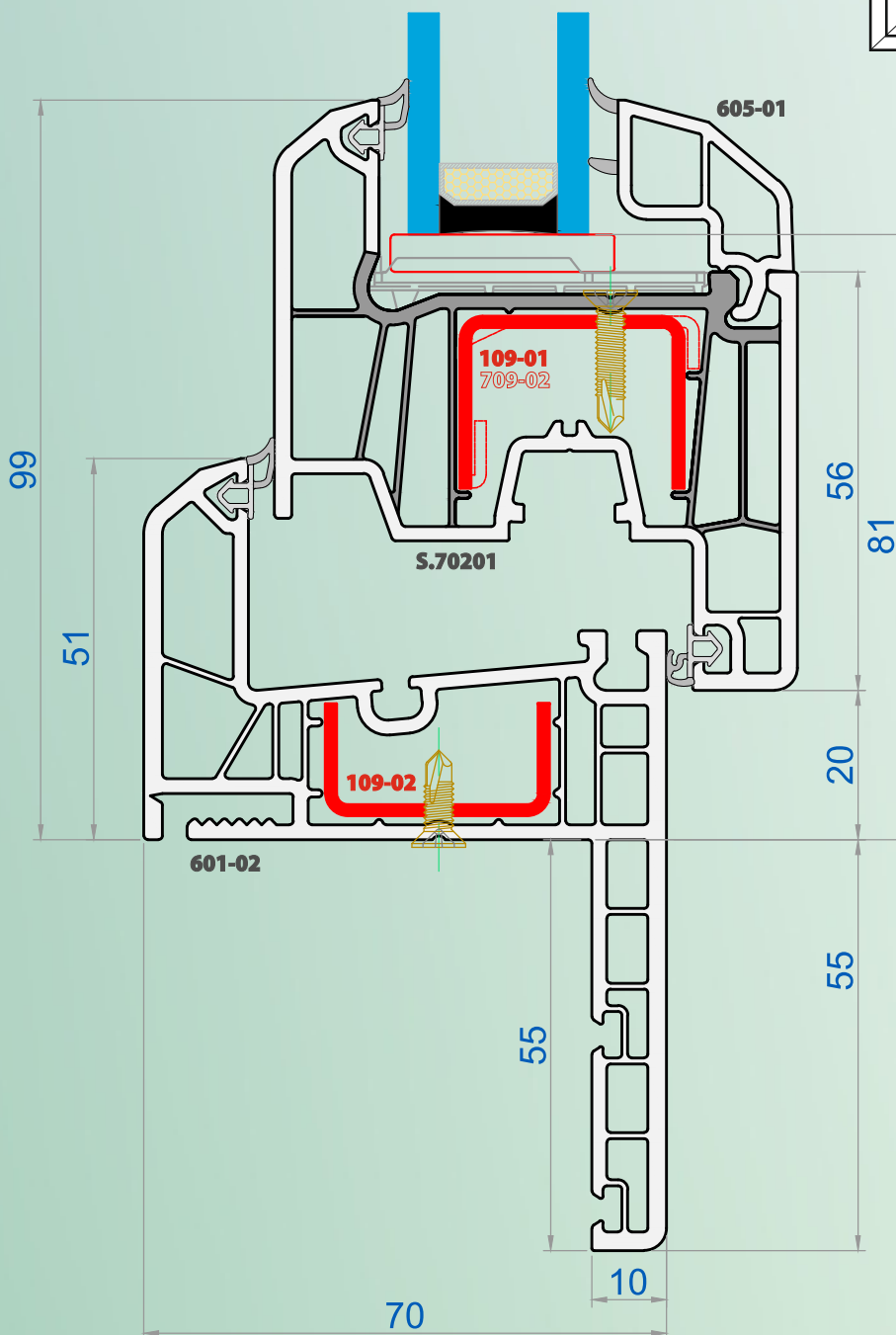
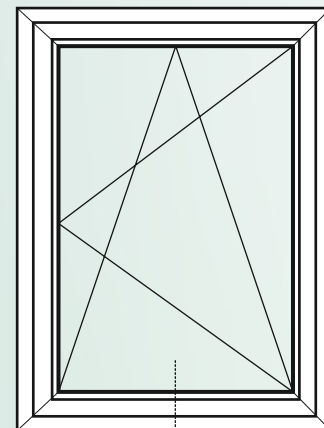

Cap.3 Combinatii de profile - serii complementare

Profil rama - **701-01**

Profil cercevea - **S.70201**

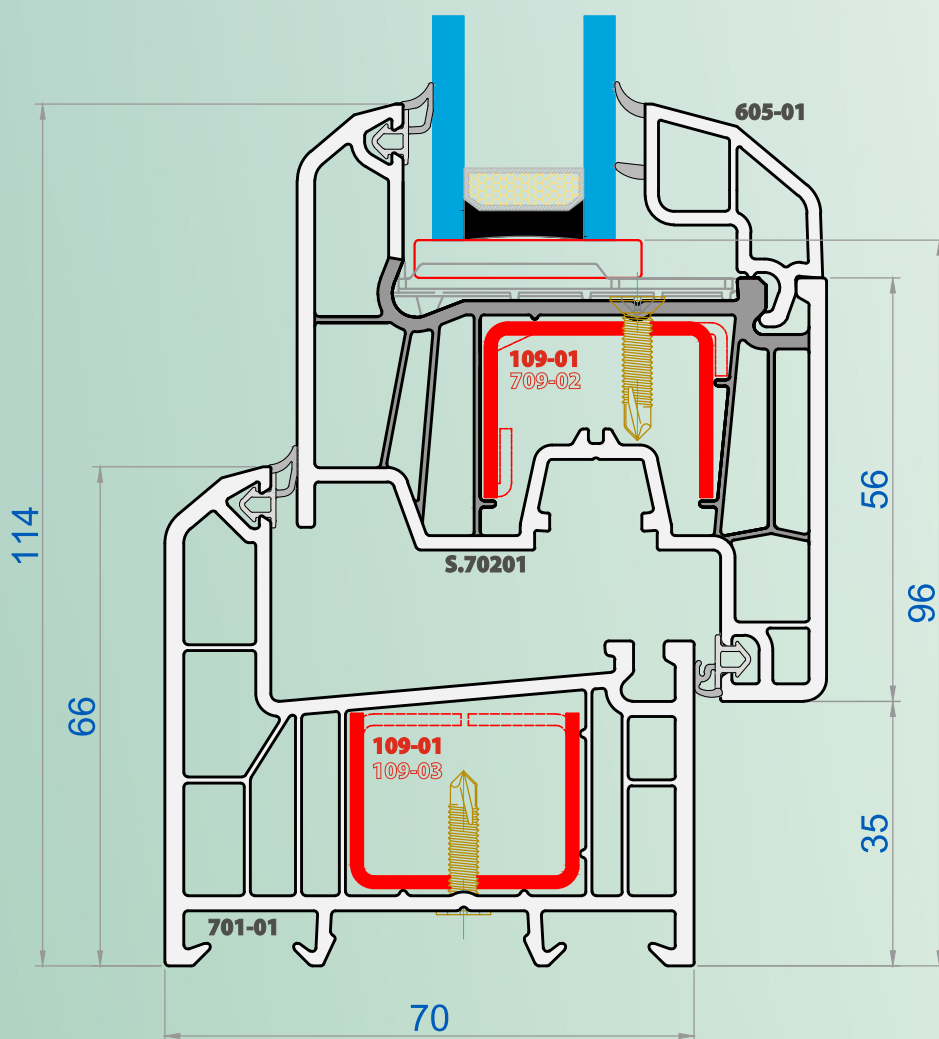
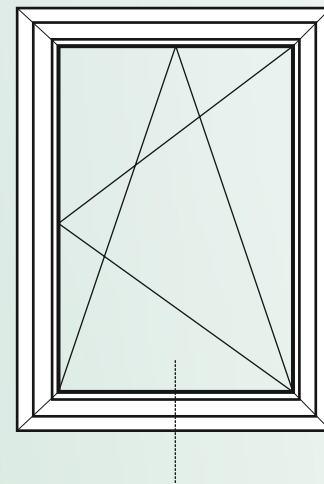

Cap.3 Combinatii de profile - serii complementare

Profil rama - **701-01**

Profil cercevea - **S.70202**

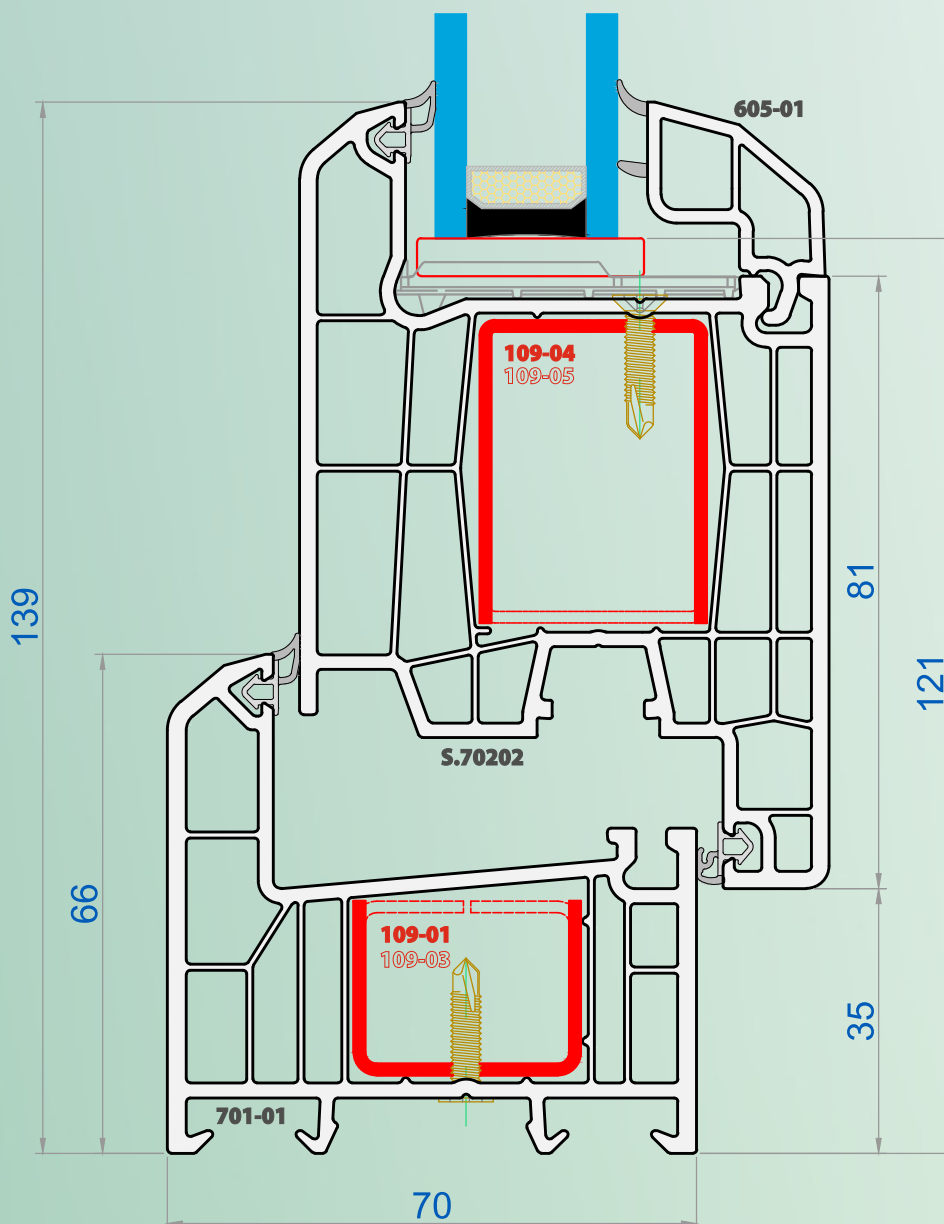
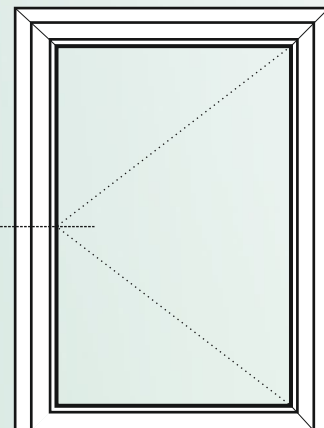

Cap.3 Combinatii de profile - serii complementare

Profil rama - **701-01**

Profil cercevea - **S.70203**

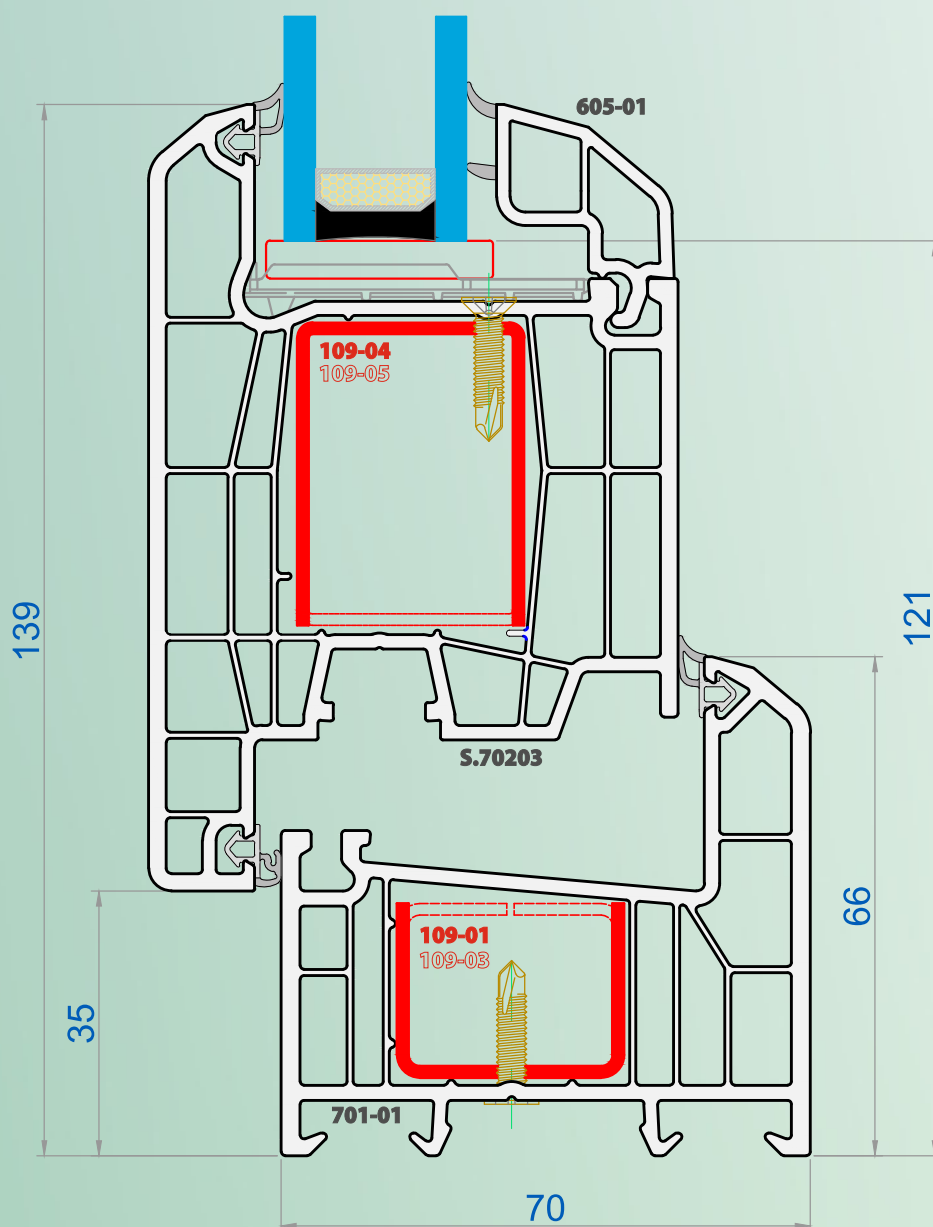
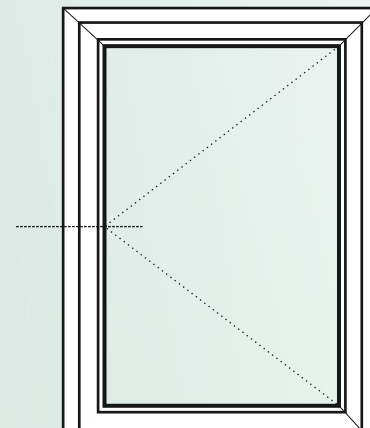

Cap.3 Combinatii de profile - serii complementare

Profil montant - **703-01**  
Profil cercevea - **S.70201**

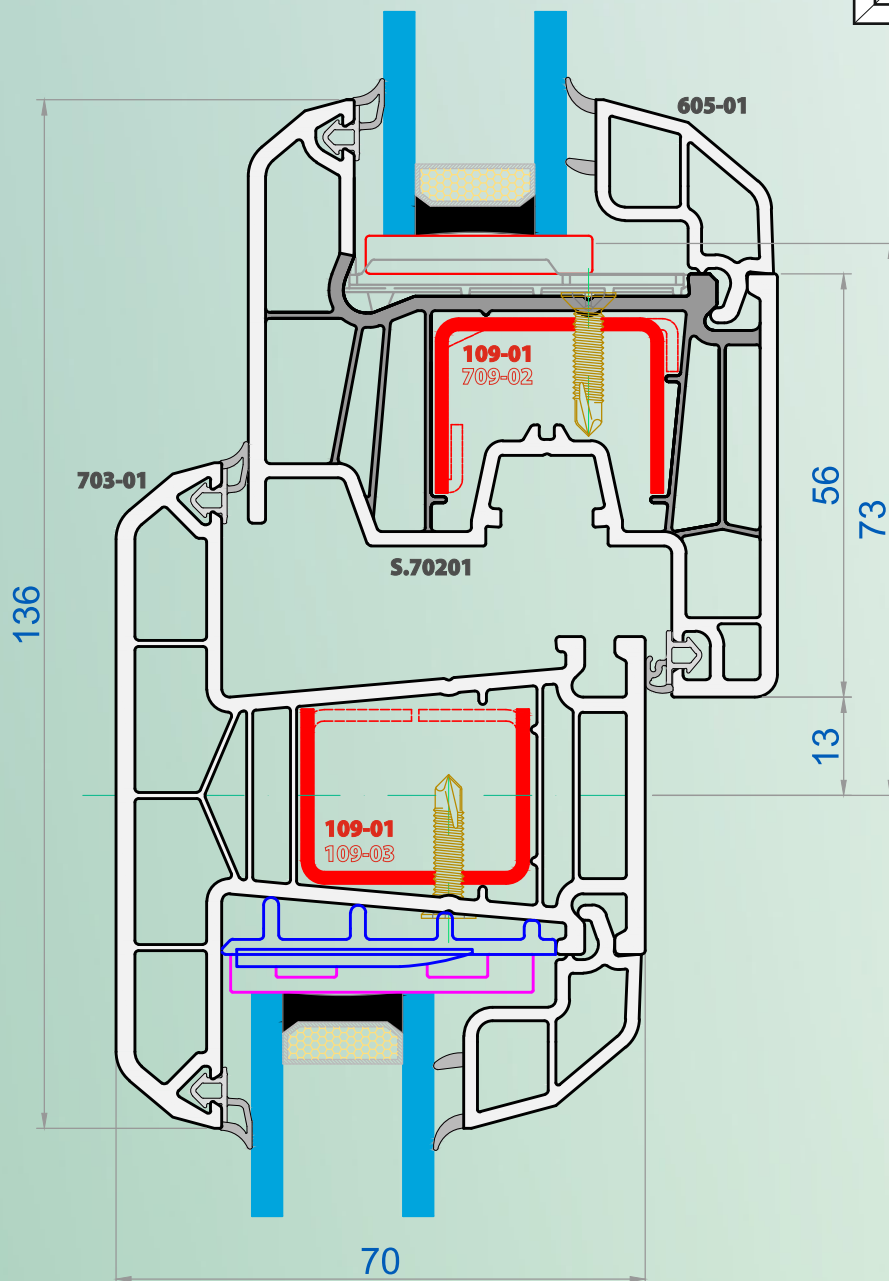
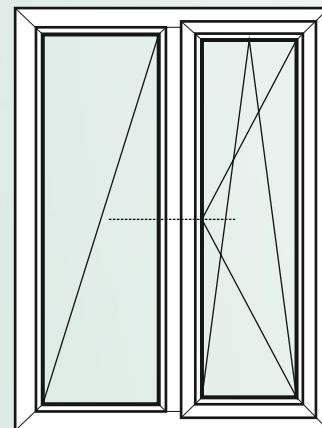

Cap.3 Combinatii de profile - serii complementare

Profil montant - **703-01**  
Profil cercevea - **S.70201**

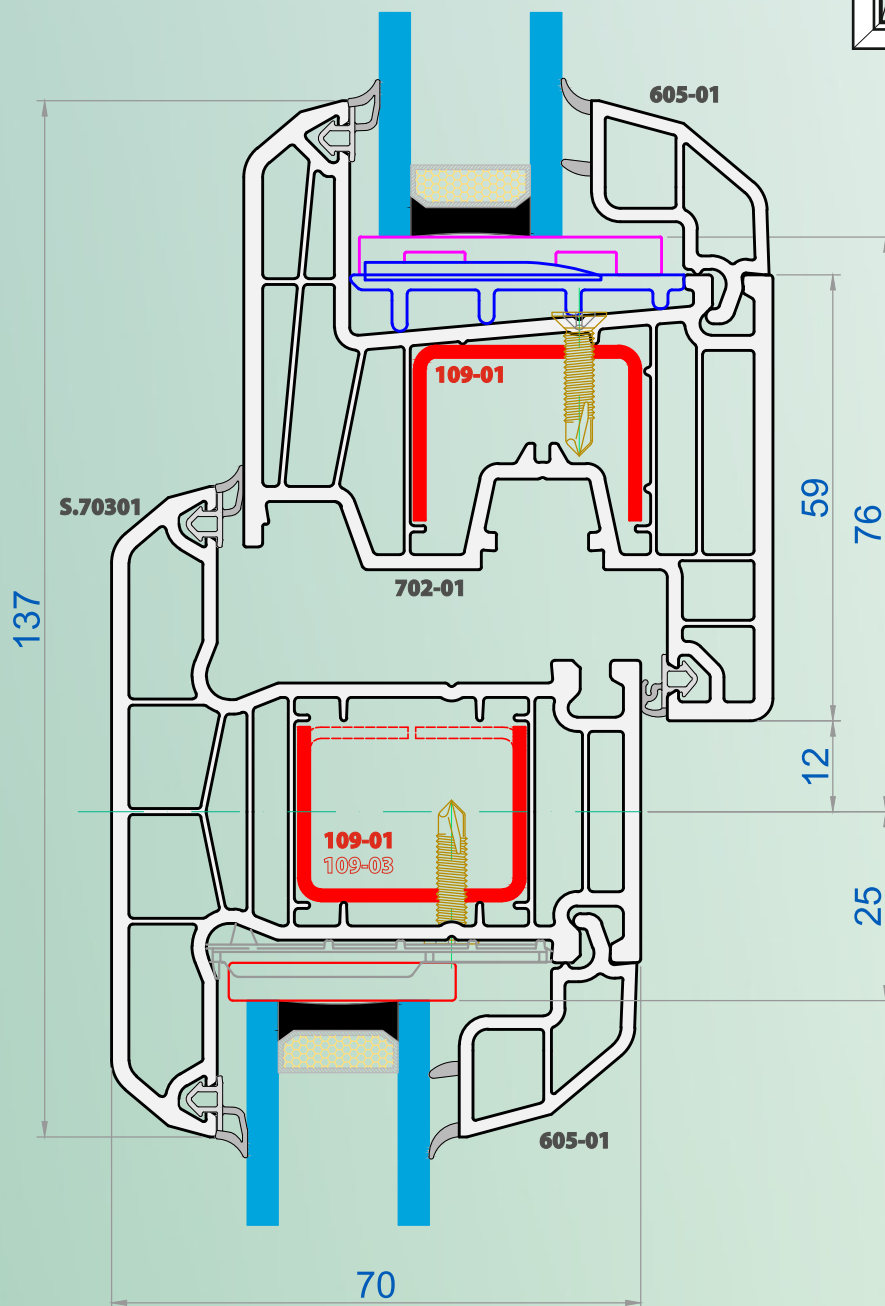
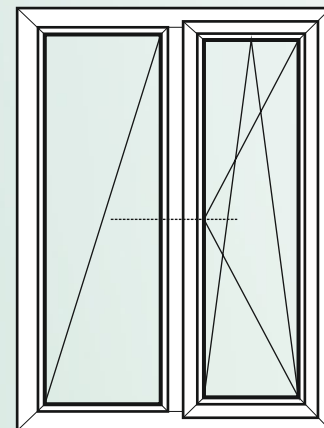

Cap.3 Combinatii de profile - serii complementare

Profil montant mobil - **S.70401**

Profil cercevea - **602-04**

Profil cercevea - **602-04**

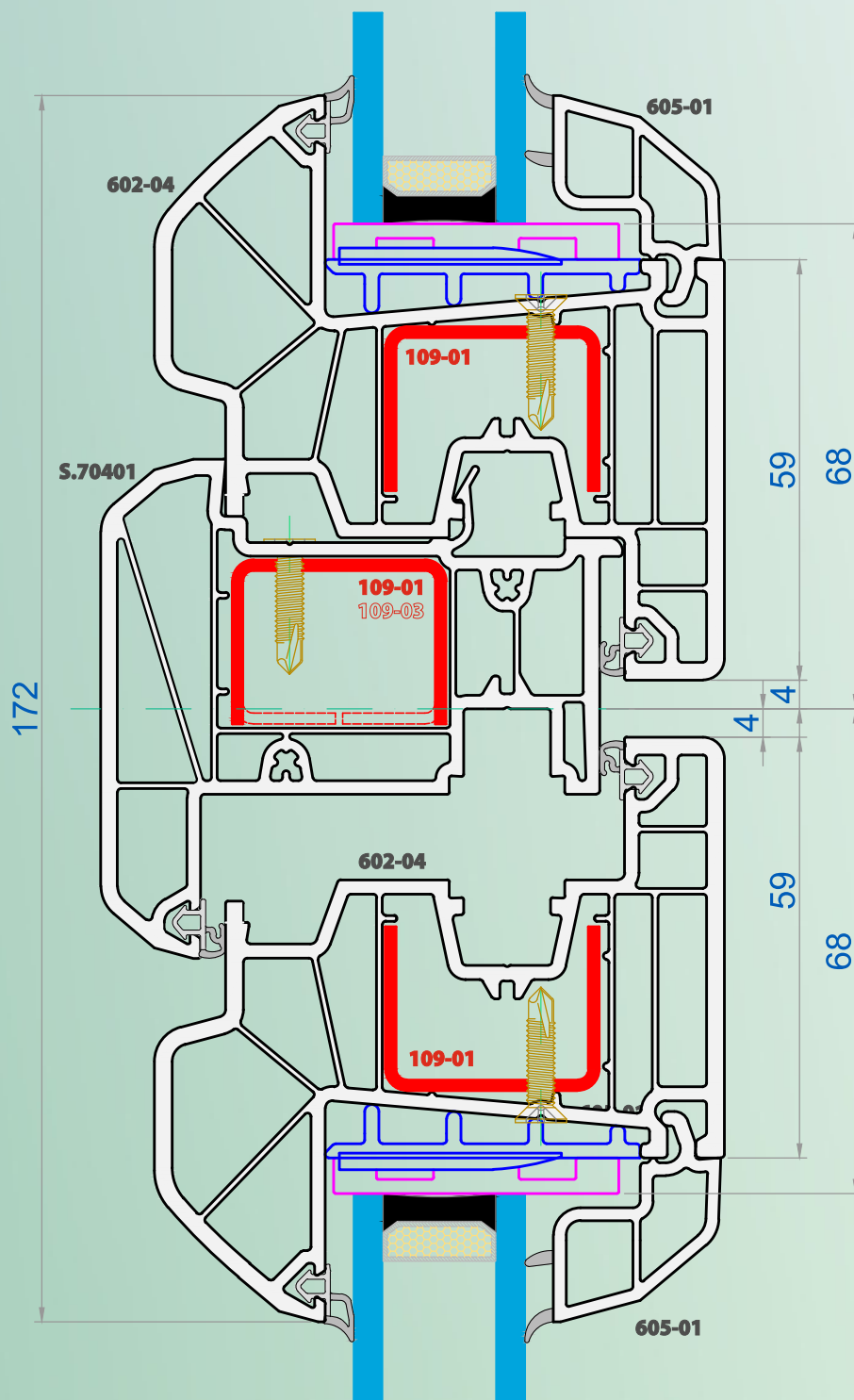
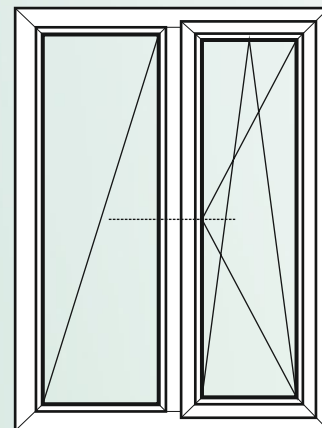

Cap.3 Combinatii de profile - serii complementare

Profil montant mobil - **S.70401**

Profil cercevea - **602-01**

Profil cercevea - **602-01**

